

A TREND STUDY OF ATMOSPHERIC METHANE:  
1965-81 GC AND POLAR ICECORE MEASUREMENTS

Suresh Santanam  
B.Tech. Kakatiya University, India, 1981

A thesis submitted to the faculty  
of the Oregon Graduate Center  
in partial fulfillment of the  
requirements for the degree  
Master of Science  
in  
Environmental Science

October, 1985

The thesis "A Trend Study of Atmospheric Methane: 1965-81 GC and Polar Icecore Measurements" by Suresh Santanam has been examined and approved by the following examination committee.

---

M.A.K. Khalil, Thesis Advisor  
Professor

---

Reinhold A. Rasmussen  
Professor

---

Robert C. Harriss  
Senior Scientist  
NASA Langley Research Center

Dedication

To

*JV*

## Acknowledgements

I am most grateful Professor Khalil for introducing me to the field of global atmospheric research and encouraging me to undertake this work. Dr. Khalil provided the financial support, and the opportunity to attend the various meetings in U.S. and Canada. I thank Professor Rasmussen and Dr. Harriss (NASA Langley Research Center) for reading the thesis and providing critical remarks.

I appreciate the encouragement and advise of Professor Barofsky. I thank Dr. Huntzicker and Dr. Pankow for giving me a broader perspective of Environmental Science. I thank my co-students especially Mike Rosen, Ken Hart, and Steve McDow, who were a source of inspiration and friendship. Very special thanks go to Dr. Rao Gudimetla for many of the useful discussions during the pursuit of this degree.

I thank Chris Lightcap, Maureen Seaman, and Barbara Turpin for assistance during literature search. I am indebted to the Computer Science and Engineering Department for the use of VAX computer.

Parts of this project were supported by a grant from the National Science Foundation (#ATM-8414020). Additional support was provided by the Biospherics Research Corp. and the Andarz Co.

## Table of Contents

|                                    |     |
|------------------------------------|-----|
| Title Page                         | i   |
| Acknowledgements                   | iv  |
| List of Figures                    | vii |
| List of Tables                     | ix  |
| Abstract                           | x   |
| 1. Introduction                    | 1   |
| 2. Old GC Measurements             | 4   |
| A. Introduction                    | 4   |
| B. A Compilation and Review        | 5   |
| C. Seasonal and Global Corrections | 15  |
| D. Trend Analysis                  | 16  |
| E. Conclusions                     | 19  |
| 3. Systematic Methane Measurements | 49  |
| A. Introduction                    | 49  |
| B. A Review                        | 50  |
| C. Trend Analysis                  | 52  |
| D. Conclusions                     | 54  |
| 4. Methane Record in Ancient Air   | 65  |
| A. Introduction                    | 65  |

|   |     |
|---|-----|
| B. A Compendium of Icecore Data                         | 65  |
| C. A Critical Review                                    | 69  |
| D. Trend Analysis of Icecore Data                       | 70  |
| E. Conclusions  | 73  |
| 5. IR Spectroscopic and Russian $CH_4$ Data             | 86  |
| A. Introduction   | 86  |
| B. IR Measurements                                      | 86  |
| C. Review and Trend Analysis                            | 89  |
| D. Russian Methane Data                                 | 91  |
| 6. Theoretical Studies                                  | 100 |
| A. Introduction   | 100 |
| B. Sources of Atmospheric Methane                       | 100 |
| C. Possible Effects of Increasing<br>Atmospheric $CH_4$ | 104 |
| D. Concluding Remarks                                   | 107 |
| 7. General Conclusions                                  | 114 |
| 8. References   | 116 |
| Vita  | 125 |

## List of Figures

|       |   |    |
|-------|---|----|
| 2.D.1 | Methane Trend During 1965-81  | 21 |
| 2.D.2 | Methane Trend (1965-81) from Yearly Average Values                  | 22 |
| 2.D.3 | Analysis of Methane Trend by Groups                                 | 23 |
| 2.D.4 | Northern and Southern Hemispheric Methane Trends                    | 24 |
| 2.D.5 | A Comparison of Ehhalt's Revised with Unrevised $CH_4$ Measurements | 25 |
| 2.D.6 | Running Average Concentrations of $CH_4$                            | 26 |
| 3.B.1 | Automatic Gas Sampling System at Cape Meares, Oregon                | 55 |
| 3.C.1 | Plot of Monthly Mean Methane Concentrations                         | 56 |
| 3.C.2 | Trend Analysis of Cape Grim, Tasmania Methane Measurements          | 57 |
| 3.C.3 | Trend Analysis of Mawson, Antarctica $CH_4$ Data                    | 58 |
| 3.C.4 | Methane Increase from Blake et al. (1982)                           | 59 |
| 4.D.1 | Methane Record in Polar Icecores                                    | 74 |
| 4.D.2 | $CH_4$ Trend in the Last 1000 Years                                 | 75 |
| 4.D.3 | Relative Rate of Change of Methane in the Last 500 Years            | 76 |

|       |   |     |
|-------|---|-----|
| 4.D.4 | A Comparison of Stauffer et al (1985)<br>and Rasmussen and Khalil's (1984) Datasets | 77  |
| 6.B.1 | A Plot of Population and Methane Sources<br>in the Last Four Centuries              | 109 |
| 6.C.1 | Block Diagram of Effects of<br>Increasing Atmospheric $CH_4$                        | 110 |
| 6.C.2 | Methane Oxidation Process in the<br>Atmosphere                                      | 111 |



## List of Tables

|       |   |     |
|-------|---|-----|
| 2.B.1 | A Compilation of Methane Measurements                                   | 27  |
| 2.C.1 | Seasonal Correction Matrix  | 40  |
| 2.C.2 | Latitudinal Correction Factors  | 41  |
| 2.D.1 | Seasonally and Globally Corrected<br>Monthly Mean $CH_4$ Concentrations | 42  |
| 2.D.2 | Summary of Trends   | 47  |
| 2.D.3 | Summary of Trends<br>(Non-parametric Theil tests)                       | 48  |
| 3.B.1 | Monthly Average Methane Concentrations<br>(Rasmussen and Khalil, 1983)  | 60  |
| 3.B.2 | Monthly Mean Methane Concentrations at<br>Cape Grim, Tasmania           | 63  |
| 3.B.3 | Monthly Mean Methane Concentrations at<br>Mawson, Antarctica            | 64  |
| 4.B.1 | $CH_4$ Concentrations in Polar Icecores                                 | 78  |
| 4.D.1 | Relative Rate of Increase of $CH_4$                                     | 85  |
| 5.B.1 | IR Measurements of Methane  | 96  |
| 5.C.1 | Error Analysis of Integrated Absorption                                 | 97  |
| 5.D.1 | Russian IR/Laser Measurements of $CH_4$                                 | 98  |
| 6.B.1 | Global Sources and Production of $CH_4$<br>(Ehhalt and Schmidt, 1978)   | 112 |
| 6.B.2 | Global Methane Source Inventory<br>(Khalil and Rasmussen)               | 113 |

## ABSTRACT

### A TREND STUDY OF ATMOSPHERIC METHANE: 1965-81 GC AND POLAR ICECORE MEASUREMENTS

Suresh Santanam  
Oregon Graduate Center  
Beaverton, Oregon

Thesis Advisor: Professor M.A.K. Khalil

An investigation of methane increase during the period 1965-81 is presented. A critical review of the literature has been carried out to isolate background methane measurements. A seasonal and global correction procedure has been applied to these selected GC measurements of different researchers. The corrected data have been analyzed to quantify the trend of methane. The results show an annual methane rise of about 1%. A survey of continuous, systematic measurements of methane made in the 80s indicate a similar result.

Polar ice core measurements of methane, both from arctic and antarctic, have been examined to determine the period during which the recent rapid rise has begun. The analyses demonstrate that methane increase started about 150 years ago. A doubling of atmospheric methane level during this period has now occurred.

A review of IR spectroscopic data and Russian methane measurements has also been carried out. The Russian observations have large variabilities associated with them; the higher mean of these data indicate possible non background levels of methane.

Analysis of  $CH_4$  sources and possible effects of increasing methane imply that a 20% depletion of hydroxyl radicals may already have occurred, while a large portion of the  $CH_4$  increase may have occurred because of increasing emissions from sources controlled by human activities.

## 1. Introduction

The rise of the species *Homo sapiens* to its present position of global predominance has taken place over the period of last ten thousand years in the two billion years of existence of life on earth. Man is embedded in nature; but the benefits of his continued efforts to manipulate natural resources to his advantage are debatable. The modifications imposed on nature by the human race can cause unanticipated problems that may be more harmful than the conditions that motivated the modifications in the first place. The acceptance of such transformation in view of their benefits, however, is a value of judgement. It takes scientific information and evidence to assess both risks and benefits of the multitude of man-made changes on planet earth. On a more specific level, earth's atmosphere is one such element of nature that has been subjected to possible degradation by human activities.

The earth's atmosphere with its numerous constituents is in a state of thermal and chemical equilibrium. The intermingled nature of these species and their role in the atmosphere complicates any study of global pollution, and its detrimental effects on earth's dynamic equilibrium. As a first step in understanding this intricate phenomena, the scientific concern has been focused on interpreting the trends, cycles, seasonal variations, and the global concentrations of the individual constituents.

In this thesis, I will present the data analysis that has been applied to evaluate the trends of one of the atmospheric trace species, methane. In particular, tropospheric methane measurements of the period 1965-81 will be examined in close detail to extract the global methane rise observed in more recent studies.

The historical measurements of methane were done using combustion product analysis. Boussingault, in late 1700s, first reported the possible presence of methane in Paris, determined by the above mentioned procedure, and presented a methane level of 10 ppmv in air (Blake, 1984). In 1898, Armand Gautier reported the presence of methane using a similar measurement technique. Marcel Migeotte, in 1948, identified and confirmed the presence of  $CH_4$  in earth's atmosphere using infrared spectroscopic technique. Migeotte is recognized as having first measured methane, in isolation, since earlier measurements determined C/H ratio which was subjected to uncertainties due to the presence of several other hydrocarbons found in urban air.

Kindled by the ability to indirectly measure methane, many scientists focused their attention on determining the global distribution, and atmospheric levels of this trace gas. In mid 50s first quantitative measurements of methane using gas chromatographic (GC) method were reported. The GC technique has since become the standard analytical procedure for determining atmospheric methane mixing ratios. The focus then turned on to examining the seasonal variations, and latitudinal and vertical distributions. The recent observations (Rasmussen and Khalil, 1981a) were made on a continuous basis facilitated by high precision equipment and electronic data processing capabilities.

The principal objective of this thesis is to determine the temporal variation of tropospheric methane concentration from 1965-81 GC measurements. It is pertinent to mention here that these measurements were made by various scientists at different locations. In Chapter 2, I will present the review of the  $CH_4$  literature of the period 1965-81. A temporal and seasonal correction procedure and the trend analysis of the corrected methane data are also presented in this chapter.

The secondary goals include determination of the starting period of recent methane rise, review of continuous measurement literature, and a review cum analysis of infrared (IR) observations and Russian methane literature. Chapter 3 deals with continuous and systematic GC measurements of methane. The polar ice core measurements of  $CH_4$  provide a long term record that goes back to several thousand years. A review and analysis of icecore data forms the body of Chapter 4. The starting period of recent methane increase is also determined from manipulation of the polar icecore data. Infrared observations form a set of indirect methane information made available in the 50s. Chapter 5 concentrates on a critical review of this literature. The Russian measurements of  $CH_4$  using IR and He-Ne laser techniques are also presented in this chapter. Some of the theoretical aspects of atmospheric methane are presented in Chapter 6. Global source budget, possible adverse effects of  $CH_4$  rise, and a theoretical trend study are addressed in this chapter from the viewpoint of globally increasing methane.

## 2. Old GC Measurements

### 2.A Introduction:

Analysis of atmospheric methane using gas chromatographic technique started about a few decades ago. Many scientists were keen to investigate the global distribution, seasonal variations, and others aspects of this previously unstudied trace gas. The continued interest in the study of methane led a large number of investigators to analyze the atmosphere for this trace gas at various locations and time using the newly available analytical method. Consequently, the  $CH_4$  measurements obtained by different observers are distributed in time and space. It is also to be noted that occasional interlaboratory comparison of both standards and measurements, as is being done now, was absent during the early periods of these measurements.

In this chapter all GC/FID measurements made during the period 1965-81, excluding the systematic measurements, and a review of the data are presented. The concentrations observed by several investigators are corrected for seasonal variations using "ratio method" and the systematic measurements. The seasonally corrected data are then adjusted to a representative global average using 1983-84 observations from NOAA/GMCC global network of stations. The remainder of the chapter is devoted to trend analyses of the reconditioned data and to look at increase of methane concentration during 1965-81. The three data sets that will be considered here for analysis are: (i) the entire reconditioned data set for 1965-

81 (ii) groupwise data ie., Rasmussen's; Ehhalt's; others, and (iii) Northern and Southern hemispheric measurements. The chapter is concluded with a comparison of trends observed by other workers.

## 2.B A Compilation and Review:

Many of the early efforts in measuring methane were oriented towards a study of urban pollution (Altshuller and Bellar, 1963; Altshuller et al., 1965). Ortman (1965) monitored methane and other hydrocarbons in the atmosphere using a gas chromatograph (GC) with flame ionization detector (FID). Ortman's Cincinnati study reflects the nature of many similar urban measurements ie., the urban air is highly contaminated by local sources and does not represent the background levels of methane found in clean air. Urban data have been excluded from this study for the above reason.

Bainbridge and Heidt (1966), in a pioneering effort, studied the vertical profiles of methane from aircraft and balloon flights. A gas sampling device consisting of eight evacuated bottles connected to a manifold, was used for the study. The ground level samples were collected over Louisiana and central Texas. The GC measurements of  $CH_4$  in the samples are presented in Table 2.B.1. The authors found that their measurements were consistent with results obtained by Goldberg (1951) over Michigan during spring of 1950 using optical spectroscopy. As will soon become evident from trend analyses, the reported constancy of methane concentrations over the period 1950-65 may be an artifact of inaccuracies in either of these procedures.



Cavanaugh et al. (1969) measured clean air concentrations of methane at Point Barrow, Alaska during August-September, 1967. The samples were collected at U.S. Naval Arctic Research laboratory from uncontaminated arctic air masses. Methane concentration was determined by hydrogen flame detector with a dual channel Varian Aerograph Model 204B analyzer using a continuous sample air flow. The authors report frequent calibration procedures adopted throughout the study. The measurements are presented in Table 2.B.1. The authors also report that their observed average concentration of 1.59 ppm agrees well with the other measurements made at that time.

Stephens and Burleson (1969) analyzed the distribution of light hydrocarbons in ambient air from the groups of samples collected in San Bernardino and San Gabriel mountains of Southern California during March, 1968. The authors analyzed the samples using GC with a Porapak N column (length: 1.52m) operated at 60°C. The equipment was capable of analyzing  $CH_4$  concentrations down to 1ppbv level and the calibration procedure gave a relative standard deviation of just over 1% at the highest concentrations. The GC analyses yielded an average methane concentration of 1.39 ppmv which is included in Table 2.B.1. The authors report that similar background levels (1410 ppbv) were observed at Hawaii.

Stephens (1984) recently reported a set of clean air methane measurements. The data comes from a group of earlier sampling studies (Stephens and Burleson, 1969) but unpublished. The measurements included in Table 2.B.1 are that reported by the author from clean air sample sets (based on Santa Ana wind tra-

jectories) collected during April, 1968 - March, 1969. The author also notes that the Honolulu measurements, even though slightly higher due to possible automobile related contamination, are in agreement with clean air measurements of California samples.

Swinnerton et al. (1969) measured atmospheric and surface water methane content in an oceanographic cruise from Washington D.C. to Puerto Rico. The samples were collected from just above the water surface and analyzed by gas chromatography for methane and carbon monoxide. The authors found distinctly higher levels of methane in stations near Potomac river indicating possible local sources. The possibility of contamination due to urban pollution from Washington D.C. can not be ruled out. Accordingly, the average for rest of the measurements is presented in Table 2.B.1 and will only be considered in trend analysis calculations.

In a research program to investigate methane in various marine environments, Lamontagne et al. (1973) measured the trace gas in surface waters as well as open atmosphere. The samples were collected during an NRL ship cruise from Washington D.C. to Hawaii. The samples were analyzed within one hour of collection by gas chromatography. The precision, based on daily calibrations, was  $\pm 3\%$  (Lamontagne et al., 1971). The data are presented in Table 2.B.1. The high observed methane concentration (1.7ppmv) at Washington D.C. was eliminated from trend analysis because of a possible contamination near Potomac river (Swinnerton et al., 1969).

Wilkniss and Larson (1984) recently published results from an earlier study

to measure Radon, carbon monoxide, methane, trichlorofluoromethane (F-11), and carbon tetrachloride ( $CCl_4$ ) in the Arctic atmosphere. The samples were collected aboard an NRL RP-3A Orion aircraft. The steel flasks were analyzed in the laboratory using GC. Standard gas samples were used to calibrate the method and the reported accuracy and precision are  $\pm 0.02$  and  $\pm 0.03$  (ppmv) respectively for  $CH_4$ . The authors also report high volumetric mixing ratios for methane ( $\approx 1.6$  ppmv) in the months January and September of 1974. A closer look at F-11 and  $CCl_4$  concentrations reveal that these anthropogenic trace gases were also observed to be high during January '74 and not during September '74. A possible explanation is that the  $CH_4$  measurements of January correspond to some continental air mass and not representative of clean background arctic air. A similar conclusion was reached by Khalil et al. (1985) while studying wood burning pollution at a rural site near Portland, Oregon. Also Wilkniss et al. (1975; see also Wilkniss et al., 1973) report the observation of continental air flow into the arctic region during January, 1974 and indicate that only one sample (#18) may have clean air origins. Because of this overwhelming evidence against January measurements, only data from other months is included in trend studies.

Larson et al. (1972) studied the arctic air masses during a cruise of USNS Mizar during August, 1971 in 50–80°N latitudes. Three hour samples were analyzed for CO and  $CH_4$  using GC/FID. The observed average daily concentrations are given in Table 2.B.1. The authors report no anomaly in methane measurements even though they identify some of the air masses as having origins in Russia and the U.S.

Methane and  $C_2-C_4$  hydrocarbons in North and South Pacific oceans and atmosphere were measured by Lamontagne et al. (1974). The air samples were collected from an inlet mounted on the bow of 'USCGC Glacier' on its cruise from California to McMurdo Station, Antarctica. The samples were analyzed for  $CH_4$  by GC and calibration was carried out with standards on each run. The reported average for Northern hemisphere ( $35^{\circ}$ - $10^{\circ}$ N) and Southern hemisphere ( $10^{\circ}$ N- $77^{\circ}$ S) are presented in Table 2.B.1.

The vertical distribution of chlorofluoromethanes in upper troposphere and lower stratosphere was the principal objective of the study by Seiler et al. (1978). The authors also measured  $CH_4$ , CO,  $H_2$ , and  $N_2O$  simultaneously. The measurements were made during an aircraft flight over Europe in November and December, 1976. The samples were analyzed in the laboratory using GC with FID. The authors report detection limit of 10 ppbv and a standard deviation of  $\approx \pm 5\%$  for methane. The data presented in Table 2.B.1 are obtained from the tropospheric averages in figures 7-10 of the authors' paper. The authors found  $CH_4$  mixing ratios in the northern troposphere to be 20-30% higher than those reported by Wilkniss et al. (1973) which they relate to a general increase in  $CH_4$  level.

A similar study was undertaken by Fabian et al. (1979) to observe the trace gases in mid latitudes. The samples were collected on four flights at a geographical latitude of  $44 \pm 0.5^{\circ}$ N. The  $CH_4$  analyses were carried out at three participating laboratories. The authors provide extensive information on sample collection, equipment, and the analytical procedures followed by the laboratories including detection limits and precision of measurements. The authors also indicate a possi-

ble trend based on Ehhalt's measurements (Ehhalt and Heidt, 1973; Ehhalt et al., 1975). The correction to Ehhalt's measurements (Heidt and Ehhalt, 1980) put the trend at  $\approx 0.5\%$  per year in case of first set of data (Ehhalt and Heidt, 1973) and a decrease in the second set. A point to point trend based on two sets of data, as was computed by the authors, may lead to inconclusive results. The tropospheric measurements included in Table 2.B.1 are from the data of the same study presented by the authors in their subsequent paper (Fabian et al., 1981).

Singh et al. (1979) studied the global distributions, sources and sinks of atmospheric halocarbons, hydrocarbons and sulfur hexafluoride on a ship cruise (USCG Burton Island). The insitu data were collected between  $37^{\circ}\text{N}$  and  $42^{\circ}\text{S}$  latitudes. The authors found a northern- southern hemispheric concentration difference of about 3%. The values given in Table 2.B.1 are digitized data from authors' graphical representation (figure 1).

Blake et al. (1982) reported  $\text{CH}_4$  measurements from grab samples collected over a two year period starting with January, 1978 at locations distributed between the latitudes  $55^{\circ}\text{N}$  and  $53^{\circ}\text{S}$ . The samples were analyzed using GC/FID technique with a precision of  $\pm 5\text{ppbv}$ . The authors report an average methane increase of  $52 \pm 5\text{ppbv}$  over the two year period which is in agreement with the trend observed by Rasmussen and Khalil (1981).

Another set of data from the same interhemispheric  $\text{CH}_4$  study has been reported by Mayer et al. (1982). The authors report the precision of methane measurements to be  $\pm 10\text{ppbv}$  for the samples analyzed and report no variability in absolute or relative values upon repetitive measurements. The data set is

presented in Table 2.B.1. The authors also indicate a possible discrepancy in NCAR methane measurements (see also Mayer et al., 1979).

Vertical profiles of methane obtained over eastern United States during January, 1978 were reported by Reichle and Condon (1979). The samples were collected in evacuated glass bottles aboard an aircraft and analyzed in the laboratory for  $CH_4$  content using GC/FID. The authors also report the interlaboratory comparison of primary standards with four other laboratories. The data presented in Table 2.B.1 represents the average of tropospheric profiles given in Reichle and Condon's paper (figures 1-3).

1979 International Summer Monsoon Experiment (MONEX) was designed to measure CO and  $CH_4$  in air over Saudi Arabia, India and Arabian sea (Newell et al., 1981). The sampling and analysis was done on an onboard GC equipment aboard NASA Convair 990 aircraft. Bottle samples, also collected during flight, were analyzed in the laboratory. From interlaboratory comparison of primary standards (Reichle and Condon, 1979), the authors estimate measurement error of <6% for directly measured samples and of  $\approx 7\%$  for container samples. The authors found  $CH_4$  concentrations to be relatively constant in the many vertical soundings. The tropospheric averages (extracted from figures 1a, 1b, 3 and 4) are given in Table 2.B.1.

Trace gas measurements were made by Leifer et al. (1981) during the interception of the plume from the eruption of Mount St. Helens. The samples, collected aboard Department of Energy's WB-57F aircraft during three flights in February, May and July of 1980, were analyzed at two participating laboratories.

The tropospheric averages ( $H \leq 12\text{km}$ ) for February and May flights are reported in Table 2.B.1. The methane concentrations reflect that of background levels (Cronn and Nutmagul, 1982) and the authors did not observe any increase in methane due to the eruption.

A similar study was done by Cronn and Nutmagul (1982) during which over 50 samples were collected in the period from March 28 to June 30, 1980. Thirty five of these samples were analyzed for  $CH_4$  using GC/FID system with a sensitivity of 4ppbv and a precision of 0.4%. The authors found that the methane mixing ratios were similar to background levels for tropospheric samples. A summary of the observations is given in Table 2.B.1.

Stevens and Rust (1982) measured atmospheric methane in air samples collected in rural northern Illinois upwind of any urban areas during May-June, 1980. The laboratory analyses used a procedure to convert  $CH_4$  to  $CO_2$  before isotopic analysis of  $CO_2$ . The authors indicate uncertainty in methane trend by comparing their measurements with earlier observations. The selection of older measurements plays a key role in determining the trend by such point to point comparison methods. The measurements of Stevens and Rust are presented in Table 2.B.1.

Cofer III (1982) reported methane measurements from air samples collected over north and south Atlantic oceans ( $40^{\circ}\text{N}$ - $32^{\circ}\text{S}$ ) during a cruise by 'F.S. Meteor' in October-November, 1980. A continuous sampling equipment was used to collect at least six individual samples within a few minutes of each other. The precision of measurements was  $\pm 0.02\text{ppmv}$ . The data presented in Table 2.B.1 constitutes the

averages reported by the authors for various latitudinal bands.

Singh and Salas (1982) measured methane aboard USGS 'Polar Sea' during its voyage from Long Beach, California (33°N) to Valparaiso, Chile (32°S) during November-December, 1981. Methane analysis was done on a GC with molecular sieve column. The authors report a precision of  $\pm 4\%$  for methane, from the calibration procedures that were adopted. The data presented in Table 2.B.1 correspond to latitudinal band averaged  $CH_4$  concentrations reported by the authors. The authors also suggest a possible uncertainty in  $CH_4$  trend by reference to Cavanaugh et al.'s (1969) measurements (no change was observed over 15 years) and to Wilkniss et al.'s (1973) and Ehhalt's (1974) measurements (a nearly 200 ppbv increase over a decade). The limited and subjective nature of such analyses do not provide sufficient clues to the exact methane trend and point out the need for a complete analysis of the entire available information.

Ehhalt made several measurements of atmospheric methane spread over a decade starting with 1966. The first set of observations were made during aircraft flights over Scotts Bluff, Nebraska (Ehhalt, 1967). The average concentrations obtained from vertical profiles given by the author are presented in Table 2.B.1. Ehhalt and Heidt (1973) measured vertical profiles of methane at two locations (Scotts Bluff, Nebraska; over Pacific ocean 200km offshore from Santa Barbara, California). The grab samples were analyzed for  $CH_4$  content using GC. The authors report that each sample was compared three times to a standard and that the resulting accuracy for tropospheric samples was  $\pm 3\%$ . Table 2.B.1 gives a gist of measurements extracted from seasonal vertical profiles presented by the



authors (see fig. 2 in paper). Ehhalt (1978) also studied the latitudinal variation of methane extensively during a cruise of research vessel 'Meteor' in North Atlantic and Pacific oceans. The samples were collected in evacuated stainless steel containers and shipped to the laboratory where  $CH_4$  analyses were carried out on a GC/FID system. The precision of measurements, from alternate sample/standard runs, was reported to be 0.05ppmv. The author reports that there is good agreement (better than 1%) between his data and the measurements made by Swinnerton. Ehhalt et al. (1983) analyzed methane trend using observations from various authors who applied either infrared spectroscopic (IR) or GC techniques. The authors found  $CH_4$  rise of about 0.5% per year by combining both IR and GC measurements made in the period 1948-78. The combination of data from two entirely different methods and the uncertainties associated with the IR technique (Fink et al., 1964; Stephens, 1984) has evidently led the authors to predict a lower rate of rise in methane concentration. The previously unpublished NCAR aircraft flight data reported by the authors (Ehhalt et al., 1983; see Table 1a in paper) is presented in Table 2.B.1.

Rasmussen collected several grab samples at Cape Meares, Oregon during 1975-80 (Rasmussen and Khalil, 1981b). The samples were analyzed for  $CH_4$  on the same equipment that is being used for systematic measurements. The details of the GC/FID system along with precision and accuracy are given in the next chapter. The data included in Table 2.B.1 represents monthly averages reported by Rasmussen and Khalil (1981b - see appendix).

## 2.C Seasonal and Global Corrections:

It is well established that methane concentrations vary seasonally (Khalil and Rasmussen, 1983; Fraser et al., 1984). Latitudinal distribution has also been extensively studied by various groups (Ehhalt, 1978; Wilkniss et al., 1973; Singh et al., 1979; Mayer et al., 1982; Cofer III, 1982). It is clear from the above mentioned works that any  $CH_4$  measurement made at a particular location be distinct from other measurements made at a different location or time. To bring the entire collection of GC measurements to a common base, it is necessary to apply temporal and spatial corrections to the data. The general procedure adopted here for seasonal correction is called the 'ratio method' (Khalil and Rasmussen, 1985b). The concentration ( $C_{ij}$ ) at any month  $i$  and year  $j$  is given by:

$$C_{ij} = T_{ij} + \Delta(t_{ij})$$

where  $T_{ij}$  ( $=a + bt_{ij}$ ) is noncyclical trend and  $\Delta(t_{ij})$  represents cycles. The average monthly indices (also called ratios) are computed from:

$$R_i = \frac{1}{n} \sum_{j=1}^n \frac{T_{ij}}{C_{ij}}$$

where  $T_{ij}$ s are calculated from running averages over twelve month periods and centering of the averages. The average monthly indices, generated from 72 months of data from five locations, are presented in Table 2.C.1. A recent study (Khalil and Rasmussen, 1985c) shows that El Niño phenomena may have a significant effect on atmospheric methane concentrations and accordingly this anomalous period (from May, 1982 to April, 1983) has been excluded while computing the seasonal correction matrix.

NOAA/GMCC group (Komhyr et al., 1985) has a network of over 20 monitoring stations that collect bottle samples of atmospheric air at regular intervals. The stations are spread throughout the world such that a latitudinal profile of methane can be obtained at any given period. The 1983-84 average data from 21 stations of this database has been used to compute a latitudinal profile and a global average ( $\bar{C}$ ). Then a global latitudinal index ( $R_l$ ) can be computed from:

$$R_l = \frac{C_l}{\bar{C}}$$

where  $C_l$  is the average concentration observed at any latitude  $\Phi$ . Table 2.C.2 presents the computed global average indices.

## 2.D Trend Analysis:

The seasonal and global corrections elaborated in the previous section have been applied to all GC measurements listed in Table 2.B.1. The resultant  $CH_4$  concentrations have been averaged for each month, authorwise, to yield a set of monthly averages. These averages, presented in Table 2.D.1, have been used in all trend analyses that follow.

As a first approximation, it is assumed that the measurements of different investigators are not significantly different in calibration from one another. The violation of this assumption is severe when clustering of data occurs, and not when several groups of data are combined, as in this case.

Linear regression of all corrected measurements has been carried out. The results, presented in Figure 2.D.1, show a methane trend of  $\approx 0.7\%$  per year. Figure 2.D.2 presents a similar plot for yearly averages computed from the same

data set which also exhibits a trend of approximately 0.7% per year for the period 1965-81. A further investigation of trend is done by studying the linear regression of groups of data that have measurements spread over several years. The following three groups have been considered for this investigation: (a) All sporadic measurements of Rasmussen, (b) All measurements of Ehhalt's, and (c) Rest of the GC measurements. The results are interesting to note; Groups (b) and (c) predict methane increases that are about 1.1% per year. Group (a) regression shows that the trend is about 2% per year which may be due to the fact that Rasmussen's measurements (1975-80) reflect the recent higher trend of about 2% observed by the author (Rasmussen and Khalil, 1981) from continuous data. The results of this study are depicted in graphical form in Figure 2.D.3. An enquiry of Northern and Southern hemispheric data shows that the Southern hemispheric trend is similar to that observed in Northern hemisphere (see figure 2.D.4). A summary of the trend estimations and the standard deviations ( $1\sigma$  level) are presented in Table 2.D.2. It is pertinent to note the lower methane trends were obtained whenever Rasmussen and Khalil's observations and Ehhalt's measurements are grouped together with the rest of GC data. It is clear from Table 2.D.2 that Group# (i) and Northern hemisphere case of Group# (iii), where such mixing of the data has been done, predict lower annual methane increase of  $\approx 0.7\%$ . A possible reason for this effect may be Ehhalt's systematically higher  $CH_4$  measurements. A comparison of means (Snedecor and Cochran, 1980) for the same period shows that mean of Ehhalt's measurements is higher than the mean of rest of GC data at the 5% level of significance. The analyses were performed after subtracting the corresponding trends.

The possibility of Ehhalt's measurements lowering the general trend is examined, in more detail, by studying Group# (iv) (see Table 2.D.2). When rest of GC measurements are combined with Rasmussen's data, a trend of 1.12% per year is obtained which is not significantly different from the trend observed in the analysis of rest of GC measurements alone (1.09% per year). But, when rest of GC and Ehhalt's measurements are combined the  $CH_4$  trend is lowered to about 0.7% per year. Heidt and Ehhalt (1980) revised all their  $CH_4$  measurements of the period 1965-74 by a factor of 1.2 due to some calibration error. From now on, revision corresponds to the above mentioned revision as applied to Ehhalt's measurements. Corrections represent seasonal and latitudinal corrections applied to all GC observations. In the final case of Group# (iv) a linear regression of Ehhalt's unrevised data, Rasmussen's and rest of GC measurements has been done. The observed annual  $CH_4$  increase of about 1.4% is much higher than when Ehhalt's revised observations are considered along with Rasmussen's and rest of GC data (Group# i). It is important to note the high correlation coefficients ( $\geq 0.7$ ) obtained under certain conditions. A closer examination of the group descriptions (Table 2.D.2) show that such results are obtained when either Ehhalt's measurements are excluded or Ehhalt's unrevised data are included for analysis. Figure 2.D.5 presents a graphical view of Ehhalt's revised and unrevised measurements. Heidt and Ehhalt (1980) presented this revision without any explanation of why such a revision was warranted. In addition, no statistical evidence of inaccurate calibration, requiring a large revision of 20% ( $\approx 0.25$ ppmv), was ever presented. From the discussions presented so far, it may be concluded that the upward revision of Ehhalt's measurements (Heidt and Ehhalt, 1980) may either be inaccurate

or inappropriate.

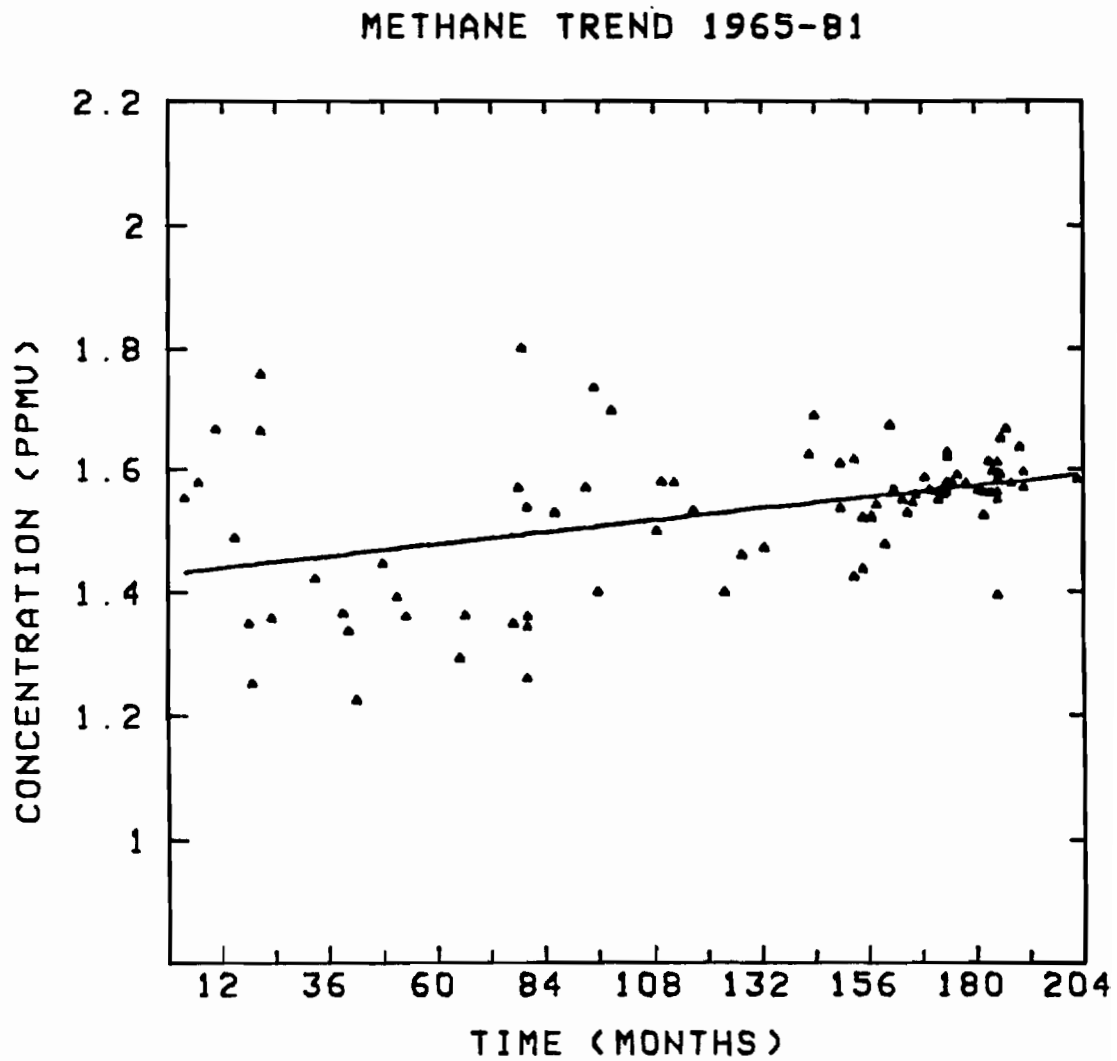
Therefore, the general trend, as deduced from 1965-81 seasonally and globally adjusted data, is of the order of 1% per year.

A series of non-parametric Theil tests (Hollander and Wolfe, 1973) on the same groupings presented in Table 2.D.2 have been carried out. The tests reveal trends that are similar to the parametric test results. The results of Theil tests are presented in Table 2.D.3. Analyses of running average slopes and running average concentrations were carried out to identify the influence any individual datum on the computed methane trend. Equal number of data points (24 in each set) were combined and the computations were performed on each set. The running slopes showed large variability and low correlation coefficients ( $<0.5$ ) when Ehhalt's revised measurements were used. Linear regression of running average  $CH_4$  concentrations showed an annual methane trend of 0.7% and 1.7% for groups having Ehhalt's revised and unrevised measurements respectively. The results are presented in Figure 2.D.6.

## **2.E Conclusions:**

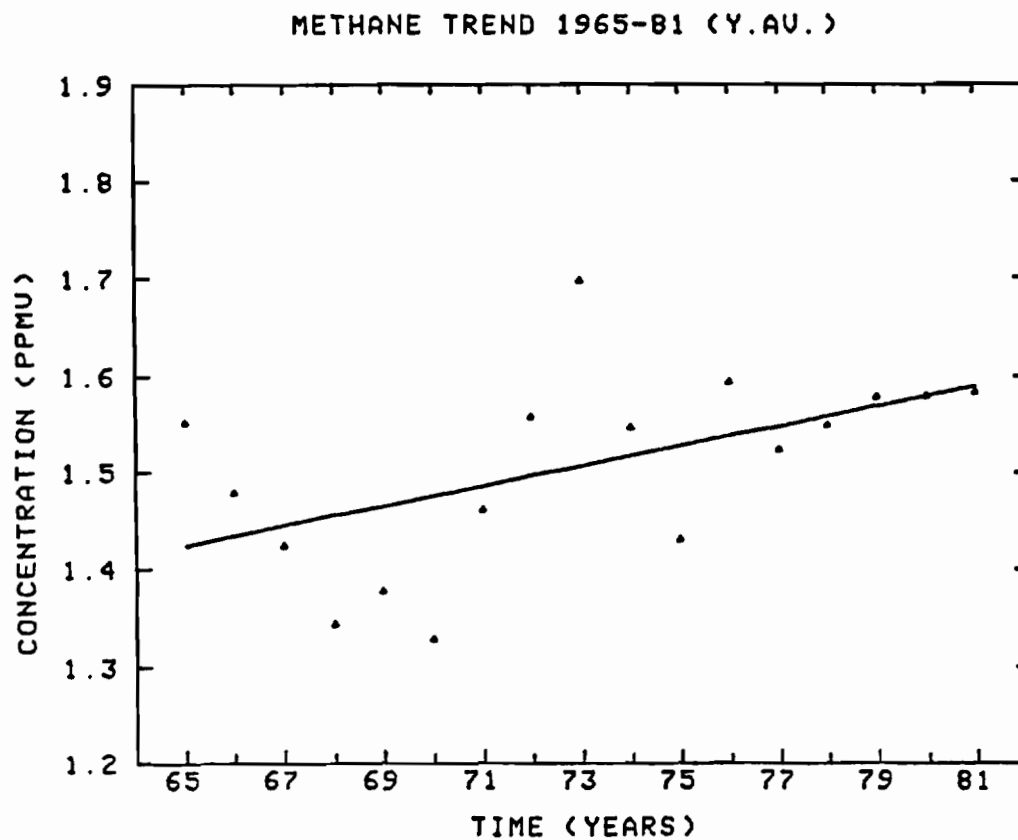
An examination of the methane trend during the period 1965-81 has been carried out in this chapter. The ratio method and the systematic measurements demonstrate the usefulness of a global averaging procedure that reduces all the methane concentration data to a common base. The trend analysis studies show that the increase in methane levels, as exhibited by 1965-81 seasonally and globally adjusted GC measurements, is about 1.0% per year. In group studies,

Rasmussen's measurements and Southern hemispheric data, reveal higher trends of  $\approx 2\%$  and  $\approx 1.5\%$  per year respectively. These two sets of observations belong to the later period of GC measurements (1975-80) and the higher observed trends are consistent with the observations of Rasmussen and Khalil (1981a). The examination of trends of the data and the correlation coefficients show that the revision factor employed by Ehhalt may be too high. It is to be noted that none of the groups, under valid data mix conditions, project a trend of  $\approx 0.5\%$  per year computed by Ehhalt et al. (1983).



**Figure 2.D.1** Plot of methane increase during the period 1965-81. Linear regression has been applied to monthly mean values that have been corrected for seasonal and global variations.





**Figure 2.D.2** Yearly average concentration of methane for the 1965-81. The measurements are generated from seasonally and globally corrected monthly mean GC data.

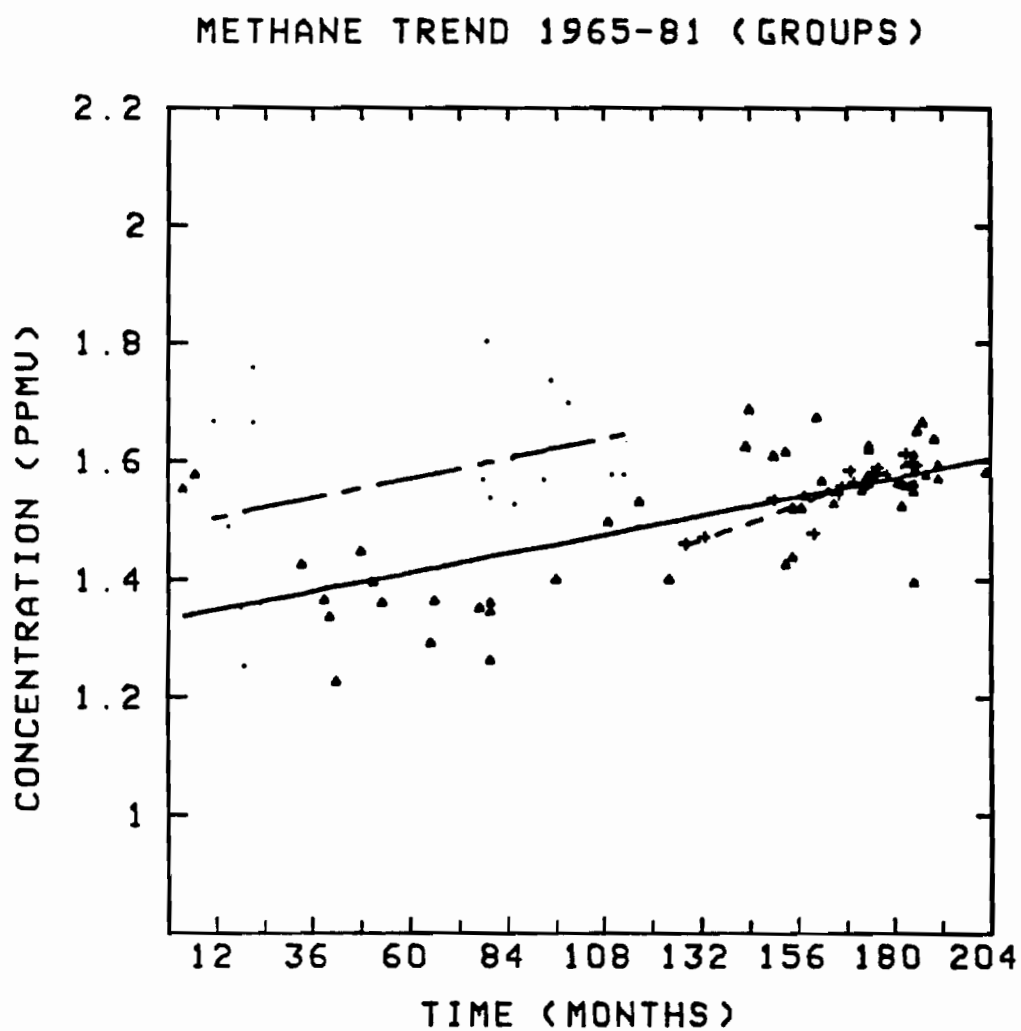


Figure 2.D.3 Analysis of methane trend by groups. Legend used in groupings:

—— and ▲ rest of GC data

- - and + Rasmussen's

- · - and • Ehhalt's

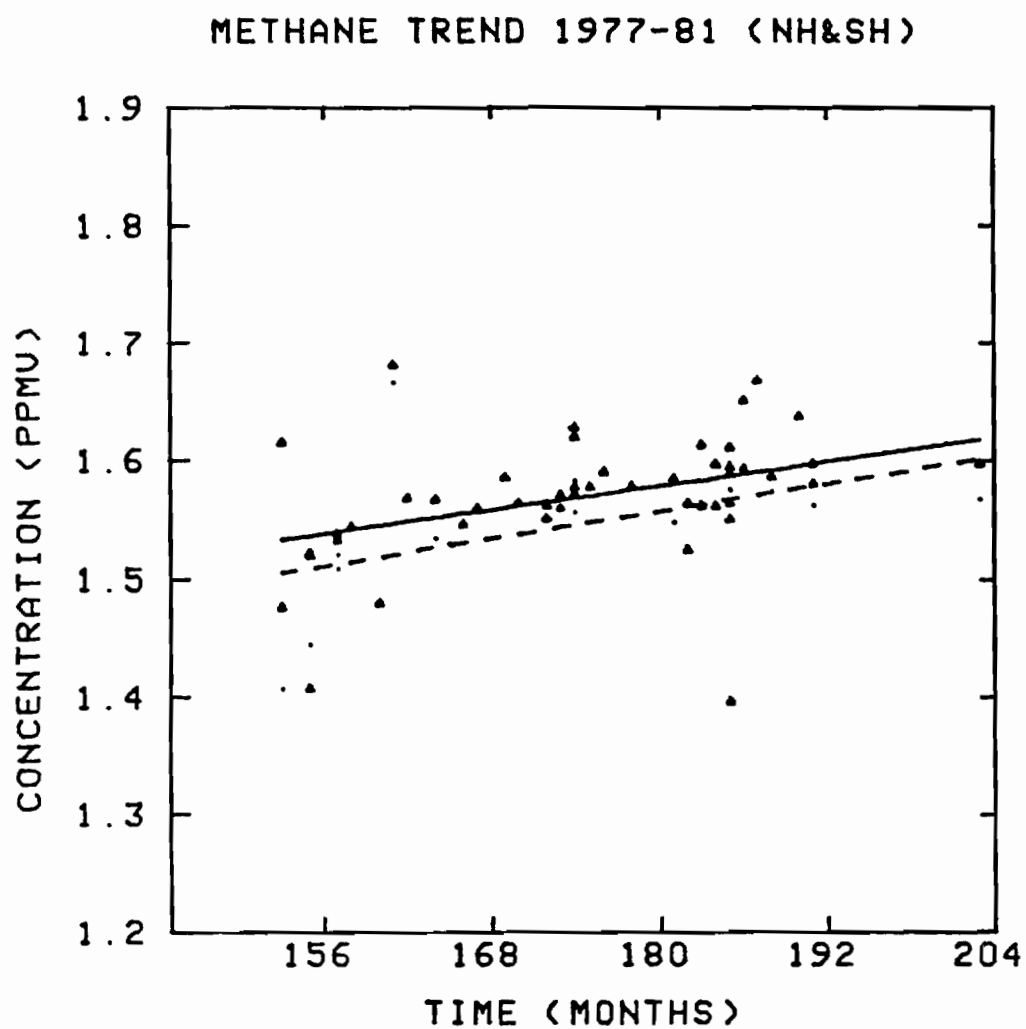


Figure 2.D.4 Comparison of Northern hemisphere and Southern hemisphere data. The legends are:

----- and • Southern hemisphere

———— and ▲ Northern hemisphere

## EHHALT'S DATA-A COMPARISON

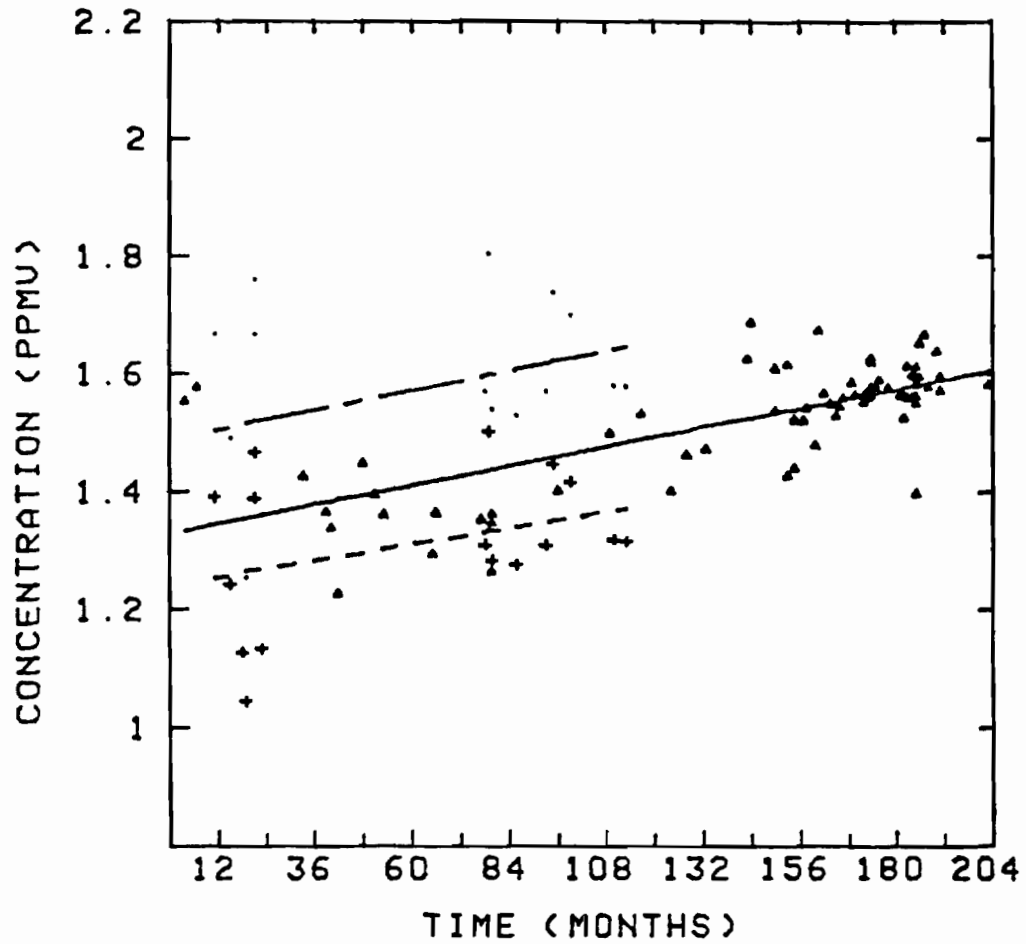
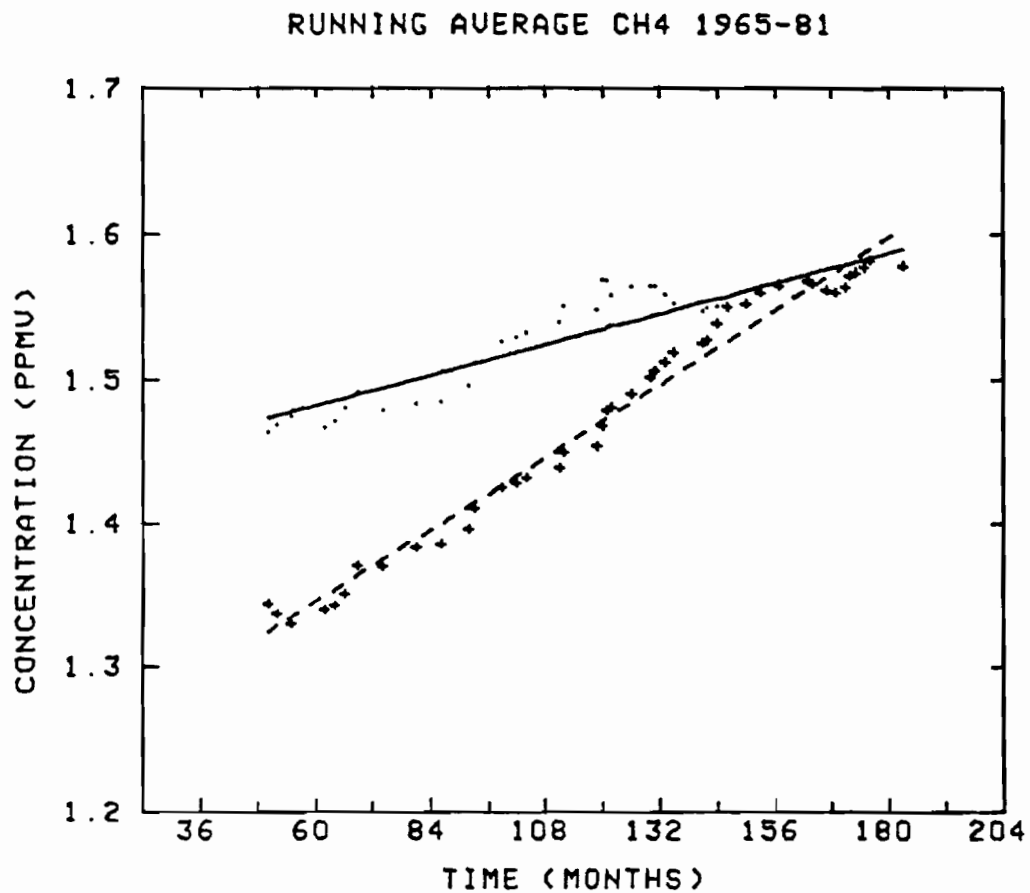


Figure 2.D.5 Test of Ehhalt's data. Ehhalt's revised and unrevised measurements have been plotted against rest of the corrected GC data. Legends are:

- and ▲ Rest of GC data
- - - and • Ehhalt's revised data
- · · and + Ehhalt's unrevised data



**Figure 2.D.6** Linear regression of running average methane concentrations.

Legend:

— and • Rest of GC & Ehhalt's revised data

--- and + Rest of GC & Ehhalt's unrevised data

**Table 2.B.1**  
**A Compilation of Methane Measurements**

| Day/<br>Month | Year | Methane<br>(ppmv) | Latitude | Reference                |
|---------------|------|-------------------|----------|--------------------------|
| April         | 1965 | 1.600             | 34°N     | Bainbridge&Heidt (1966)  |
| July          | 1965 | 1.600             | 34°N     |                          |
| September     | 1967 | 1.480             | 78°N     | Cavanaugh et al. (1969)  |
| 11 March      | 1968 | 1.390             | 33°N     | Stephens&Burlison (1969) |
| 19 March      | 1968 | 1.390             | 33°N     |                          |
| 09 April      | 1968 | 1.380             | 40°N     | Stephens (1984)          |
| June          | 1968 | 1.240             | 30°N     | Swinnerton et al. (1969) |
| 30 December   | 1968 | 1.490             | 40°N     |                          |
| 10 March      | 1969 | 1.430             | 40°N     |                          |
| 13 March      | 1969 | 1.409             | 20°N     |                          |
| 06 May        | 1969 | 1.367             | 20°N     |                          |
| May           | 1970 | 1.290             | 15°N     | Lamontagne et al (1973)  |
| June          | 1970 | 1.430             | 15°N     |                          |
|               |      | 1.220             | 38°N     |                          |
|               |      | 1.425             | 38°N     |                          |
|               |      | 1.375             | 20°N     |                          |
| May           | 1971 | 1.300             | 30°N     |                          |
|               |      | 1.330             | 15°N     |                          |
|               |      | 1.430             | 10°N     |                          |
| August        | 1971 | 1.370             | 75°N     |                          |

| Day/<br>Month | Year | Methane<br>(ppmv) | Latitude      | Reference               |
|---------------|------|-------------------|---------------|-------------------------|
|               |      | 1.410             | 76°N          |                         |
| 04 August     | 1971 | 1.480             | 65°-<br>80°N  | Larson et al (1972)     |
| 05 August     | 1971 | 1.435             | "             |                         |
| 06 August     | 1971 | 1.410             | "             |                         |
| 07 August     | 1971 | 1.382             | "             |                         |
| 08 August     | 1971 | 1.400             | "             |                         |
| 09 August     | 1971 | 1.390             | "             |                         |
| 10 August     | 1971 | 1.380             | "             |                         |
| 13 August     | 1971 | 1.470             | "             |                         |
| 14 August     | 1971 | 1.380             | "             |                         |
| 15 August     | 1971 | 1.450             | "             |                         |
| 16 August     | 1971 | 1.420             | "             |                         |
| 17 August     | 1971 | 1.360             | "             |                         |
| 18 August     | 1971 | 1.330             | "             |                         |
| August        | 1971 | 1.310             | 80°-<br>87°N  | Wilkniss et al (1973)   |
| December      | 1972 | 1.440             | 35°-<br>10°N  | Lamontagne et al (1974) |
|               |      | 1.360             | 10°N-<br>77°S |                         |
| 21 January    | 1974 | 1.630             | 75°N          | Wilkniss et al (1975)   |
|               |      | 1.670             | 80°N          |                         |
|               |      | 1.640             | 81°N          |                         |

| Day/<br>Month | Year | Methane<br>(ppmv) | Latitude     | Reference           |
|---------------|------|-------------------|--------------|---------------------|
|               |      | 1.680             | 83°N         |                     |
| 24 January    | 1974 | 1.550             | 76°N         |                     |
|               |      | 1.600             | 81°N         |                     |
|               |      | 1.630             | 82°N         |                     |
|               |      | 1.590             | 83°N         |                     |
| 25 January    | 1974 | 1.620             | 81°N         |                     |
|               |      | 1.610             | 82°N         |                     |
|               |      | 1.580             | 83°N         |                     |
|               |      | 1.610             | 84°N         |                     |
|               |      | 1.510             | 84°N         |                     |
| 24 November   | 1976 | 1.688             | 50°-<br>60°N | Seiler et al (1978) |
| 03 December   | 1976 | 1.741             | "            |                     |
| 09 December   | 1976 | 1.751             | "            |                     |
| 14 December   | 1976 | 1.759             | "            |                     |
| June          | 1977 | 1.645             | 44°N         | Fabian et al (1981) |
| Septemebr     | 1977 | 1.667             | "            |                     |
| June          | 1978 | 1.603             | "            |                     |
| June          | 1979 | 1.664             | "            |                     |
| September     | 1977 | 1.393             | 1.5°N        | Singh et al (1979)  |
|               |      | 1.475             | 14.5°N       |                     |
|               |      | 1.369             | 15°N         |                     |



| Day/<br>Month | Year | Methane<br>(ppmv) | Latitude | Reference |
|---------------|------|-------------------|----------|-----------|
|               |      | 1.456             | 28°N     |           |
|               |      | 1.500             | 29°N     |           |
|               |      | 1.425             | 37.5°N   |           |
|               |      | 1.500             | 37.5°N   |           |
|               |      | 1.639             | 37.5°N   |           |
|               |      | 1.357             | 52°N     |           |
|               |      | 1.500             | 52°N     |           |
|               |      | 1.411             | 64.5°N   |           |
|               |      | 1.488             | 64.5°N   |           |
|               |      | 1.516             | 01°S     |           |
|               |      | 1.293             | 04°S     |           |
|               |      | 1.330             | 04°S     |           |
| November      | 1977 | 1.365             | 3.5°N    |           |
|               |      | 1.416             | 5.5°N    |           |
|               |      | 1.467             | 10.5°N   |           |
|               |      | 1.375             | 20°S     |           |
|               |      | 1.417             | 23°S     |           |
|               |      | 1.432             | 26.5°S   |           |
|               |      | 1.375             | 30°S     |           |
|               |      | 1.455             | 40°S     |           |
|               |      | 1.375             | 40.5°S   |           |
|               |      | 1.378             | 90°S     |           |

| Day/<br>Month | Year | Methane<br>(ppmv) | Latitude | Reference          |
|---------------|------|-------------------|----------|--------------------|
|               |      | 1.412             | 90°S     |                    |
| January       | 1978 | 1.580             | 55°N     | Blake et al (1982) |
|               |      | 1.555             | 18°N     |                    |
|               |      | 1.539             | 13°N     |                    |
|               |      | 1.458             | 23°S     |                    |
|               |      | 1.453             | 42°S     |                    |
|               |      | 1.467             | 53°S     |                    |
| June          | 1979 | 1.612             | 55°N     |                    |
|               |      | 1.573             | 18°N     |                    |
|               |      | 1.564             | 13°N     |                    |
|               |      | 1.504             | 23°S     |                    |
|               |      | 1.503             | 42°S     |                    |
|               |      | 1.517             | 53°S     |                    |
| January       | 1980 | 1.630             | 55°N     |                    |
|               |      | 1.599             | 18°N     |                    |
|               |      | 1.585             | 13°N     |                    |
|               |      | 1.515             | 23°S     |                    |
|               |      | 1.505             | 43°S     |                    |
|               |      | 1.521             | 53°S     |                    |
| May           | 1980 | 1.652             | 67°N     |                    |
|               |      | 1.582             | 18°N     |                    |
|               |      | 1.578             | 13°N     |                    |

| Day/<br>Month | Year | Methane<br>(ppmv) | Latitude | Reference          |
|---------------|------|-------------------|----------|--------------------|
|               |      | 1.528             | 23°S     |                    |
|               |      | 1.519             | 53°S     |                    |
| August        | 1980 | 1.625             | 55°N     |                    |
|               |      | 1.583             | 18°N     |                    |
|               |      | 1.549             | 23°S     |                    |
|               |      | 1.519             | 42°S     |                    |
|               |      | 1.532             | 53°S     |                    |
| November      | 1980 | 1.635             | 55°N     |                    |
|               |      | 1.592             | 18°N     |                    |
|               |      | 1.596             | 13°N     |                    |
|               |      | 1.508             | 23°S     |                    |
|               |      | 1.517             | 42°S     |                    |
|               |      | 1.530             | 53°S     |                    |
| November      | 1977 | 1.574             | 45°N     |                    |
| June          | 1979 | 1.592             | "        |                    |
| February      | 1980 | 1.607             | "        |                    |
| May           | 1980 | 1.658             | "        |                    |
| August        | 1980 | 1.622             | "        |                    |
| November      | 1980 | 1.651             | "        |                    |
| 01 November   | 1977 | 1.574             | 43.4°N   | Mayer et al (1982) |
| 08 November   | 1977 | 1.560             | 35.3°N   |                    |
| 06 January    | 1978 | 1.496             | 36.8°S   |                    |

| Day/<br>Month | Year | Methane<br>(ppmv) | Latitude | Reference |
|---------------|------|-------------------|----------|-----------|
| 08 January    | 1978 | 1.453             | 41.5°S   |           |
|               |      | 1.467             | 53.5°S   |           |
| 09 January    | 1978 | 1.462             | 45.8°S   |           |
| 10 January    | 1978 | 1.461             | 45.7°S   |           |
| 12 January    | 1978 | 1.458             | 23.5°S   |           |
| 14 January    | 1978 | 1.565             | 16.2°S   |           |
| 21 January    | 1978 | 1.580             | 55.5°N   |           |
| 01 February   | 1978 | 1.584             | 25.2°N   |           |
| 03 February   | 1978 | 1.555             | 17.8°N   |           |
| 05 February   | 1978 | 1.539             | 13.7°N   |           |
| 09 August     | 1978 | 1.556             | 31.7°N   |           |
|               |      | 1.613             | 31.6°N   |           |
| 30 August     | 1978 | 1.494             | 42.7°S   |           |
| 31 August     | 1978 | 1.494             | 43.8°S   |           |
| 02 September  | 1978 | 1.478             | 45.5°S   |           |
| 21 September  | 1978 | 1.498             | 21.3°S   |           |
| 22 September  | 1978 | 1.482             | "        |           |
| 23 September  | 1978 | 1.498             | "        |           |
| 07 April      | 1979 | 1.566             | 20°N     |           |
| 29 May        | 1979 | 1.503             | 41.4°S   |           |
| 31 May        | 1979 | 1.517             | 53.1°S   |           |
| 02 June       | 1979 | 1.504             | 23.5°S   |           |

| Day/<br>Month | Year | Methane<br>(ppmv) | Latitude | Reference             |
|---------------|------|-------------------|----------|-----------------------|
| 05 June       | 1979 | 1.511             | 19.2°S   |                       |
| 07 June       | 1979 | 1.509             | 13.0°S   |                       |
|               |      | 1.512             | 8.1°S    |                       |
| 08 June       | 1979 | 1.546             | 3.6°S    |                       |
| 09 June       | 1979 | 1.574             | 1.2°S    |                       |
| 10 June       | 1979 | 1.577             | 3.1°S    |                       |
|               |      | 1.601             | "        |                       |
| 18 June       | 1979 | 1.617             | 61.8°N   |                       |
|               |      | 1.609             | 61.7°N   |                       |
| 19 June       | 1979 | 1.619             | 55.5°N   |                       |
|               |      | 1.608             | "        |                       |
| 20 June       | 1979 | 1.609             | 47.2°    |                       |
|               |      | 1.592             | 44.2°N   |                       |
| 21 June       | 1979 | 1.607             | 40.4°N   |                       |
| 14 July       | 1979 | 1.569             | 25°N     |                       |
| 15 July       | 1979 | 1.568             | 22.8°N   |                       |
| 17 July       | 1979 | 1.581             | 17.8°N   |                       |
| 18 July       | 1979 | 1.571             | 13.3°N   |                       |
| 20 July       | 1979 | 1.555             | 5.4°N    |                       |
| 21 July       | 1979 | 1.570             | 10.3°N   |                       |
|               |      | 1.587             | 10.5°N   |                       |
| January       | 1978 | 1.781             | 28°N     | Reichle&Condon (1979) |

| Day/<br>Month | Year | Methane<br>(ppmv) | Latitude     | Reference                |
|---------------|------|-------------------|--------------|--------------------------|
|               |      | 1.694             | 35°N         |                          |
|               |      | 1.725             | 45°N         |                          |
| May           | 1978 | 1.620             | 0°-<br>57°S  | Heidt et al (1980)       |
|               |      | 1.720             | 20°-<br>70°N |                          |
| 06 May        | 1979 | 1.566             | 26°N         | Newell et al (1981)      |
| 10 May        | 1979 | 1.610             | 22°N         |                          |
| 31 May        | 1979 | 1.558             | 16°N         |                          |
| 05 June       | 1979 | 1.635             | 25°N         |                          |
| 28 February   | 1980 | 1.560             | 29°N         | Leifer et al (1981)      |
| 13 May        | 1980 | 1.589             | 30°N         |                          |
| 28 March      | 1980 | 1.572             | 45°N         | Cronn&Nutmagul<br>(1982) |
| 02 April      | 1980 | 1.583             | "            |                          |
| 04 April      | 1980 | 1.580             | "            |                          |
| 08 April      | 1980 | 1.680             | "            |                          |
| 08 May        | 1980 | 1.650             | "            |                          |
| 18 May        | 1980 | 1.536             | "            |                          |
| 19 May        | 1980 | 1.625             | "            |                          |
| 23 May        | 1980 | 1.576             | "            |                          |
| 11 May        | 1980 | 1.440             | 40°N         | Stevens&Rust<br>(1982)   |
| 18 June       | 1980 | 1.660             | "            |                          |

| Day/<br>Month | Year | Methane<br>(ppmv) | Latitude | Reference                   |
|---------------|------|-------------------|----------|-----------------------------|
| 21 June       | 1980 | 1.680             | "        |                             |
| 25 June       | 1980 | 1.680             | "        |                             |
| 27 June       | 1980 | 1.720             | "        |                             |
| 01 July       | 1980 | 1.710             | "        |                             |
| 02 July       | 1980 | 1.680             | "        |                             |
| 10 July       | 1980 | 1.670             | "        |                             |
| 11 July       | 1980 | 1.710             | "        |                             |
| October       | 1980 | 1.700             | 40°N     | Cofer III (1982)            |
|               |      | 1.680             | 14°N     |                             |
|               |      | 1.600             | 10°N     |                             |
| November      | 1981 | 1.664             | 35°N     | Singh&Salas (1982)          |
|               |      | 1.639             | 25°N     |                             |
|               |      | 1.601             | 15°N     |                             |
|               |      | 1.557             | 5°N      |                             |
|               |      | 1.520             | 5°S      |                             |
|               |      | 1.531             | 15°S     |                             |
|               |      | 1.526             | 25°S     |                             |
| August        | 1975 | 1.490             | 45°N     | Rasmussen&Khalil<br>(1981b) |
| January       | 1976 | 1.510             | "        |                             |
| June          | 1977 | 1.570             | "        |                             |
| April         | 1978 | 1.530             | "        |                             |
| October       | 1978 | 1.608             | "        |                             |

| Day/<br>Month | Year | Methane<br>(ppmv) | Latitude | Reference              |
|---------------|------|-------------------|----------|------------------------|
| November      | 1978 | 1.613             | "        |                        |
| January       | 1979 | 1.627             | "        |                        |
| February      | 1979 | 1.608             | "        |                        |
| April         | 1979 | 1.616             | "        |                        |
| May           | 1979 | 1.605             | "        |                        |
| August        | 1979 | 1.621             | "        |                        |
| October       | 1979 | 1.642             | "        |                        |
| March         | 1980 | 1.667             | "        |                        |
| April         | 1980 | 1.652             | "        |                        |
| May           | 1980 | 1.641             | "        |                        |
| June          | 1980 | 1.630             | "        |                        |
| November      | 1965 | 1.572             | 41°N     | Ehhalt&Heidt<br>(1973) |
| March         | 1966 | 1.536             | "        |                        |
| June          | 1966 | 1.380             | "        |                        |
| October       | 1966 | 1.510             | "        |                        |
| 14 July       | 1966 | 1.272             | 41°N     | Ehhalt (1967)          |
| 28 September  | 1966 | 1.716             | "        |                        |
| 30 November   | 1966 | 1.404             | "        |                        |
| 08 June       | 1971 | 1.620             | 38°30'N  | Ehhalt (1978)          |
| 10 June       | 1971 | 1.572             | 38°53'N  |                        |
| 11 June       | 1971 | 1.716             | 39°45'N  |                        |



| Day/<br>Month | Year | Methane<br>(ppmv) | Latitude | Reference |
|---------------|------|-------------------|----------|-----------|
| 12 June       | 1971 | 1.620             | 40°23'N  |           |
| 14 June       | 1971 | 1.596             | 42°13'N  |           |
| 15 June       | 1971 | 1.596             | 42°50'N  |           |
| 16 June       | 1971 | 1.572             | 43°03'N  |           |
|               |      | 1.656             | 43°23'N  |           |
| 17 June       | 1971 | 1.560             | 43°37'N  |           |
| 18 June       | 1971 | 1.572             | 43°40'N  |           |
| 19 June       | 1971 | 1.620             | 45°26'N  |           |
|               |      | 1.512             | 46°12'N  |           |
| 20 June       | 1971 | 1.536             | 47°27'N  |           |
| 21 June       | 1971 | 1.536             | 48°20'N  |           |
| 22 June       | 1971 | 1.716             | 49°12'N  |           |
|               |      | 1.500             | 49°12'N  |           |
| 23 June       | 1971 | 1.428             | 49°33'N  |           |
|               |      | 1.548             | "        |           |
| 24 June       | 1971 | 1.620             | 49°38'N  |           |
|               |      | 1.572             | 49°57'N  |           |
| 25 June       | 1971 | 1.608             | 51°39'N  |           |
| 26 June       | 1971 | 1.728             | 53°44'N  |           |
| 28 June       | 1971 | 1.896             | 20°10'N  |           |
| 02 July       | 1971 | 1.848             | 19°35'N  |           |
| 06 July       | 1971 | 1.740             | 24°33'N  |           |

---

| Day/<br>Month | Year | Methane<br>(ppmv) | Latitude | Reference          |
|---------------|------|-------------------|----------|--------------------|
| 08 July       | 19   | 1.848             | 25°01'N  |                    |
| August        | 1971 | 1.580             | 41°N     | Ehhalt et al(1983) |
| February      | 1972 | 1.560             | 35°N     |                    |
| September     | 1972 | 1.610             | "        |                    |
| November      | 1972 | 1.780             | 32°N     |                    |
| March         | 1973 | 1.740             | "        |                    |
| February      | 1974 | 1.610             | "        |                    |
| May           | 1974 | 1.610             | "        |                    |

**Table 2.C.1**  
**Seasonal Correction Matrix**

| Month     | Latitude |         |        |        |         |         |
|-----------|----------|---------|--------|--------|---------|---------|
|           | 90-61°N  | 60-31°N | 30-0°N | 0-30°S | 31-60°S | 61-90°S |
| January   | 0.9880   | 1.0024  | 0.9965 | 1.0002 | 1.0006  | 1.0006  |
| February  | 0.9819   | 1.0007  | 0.9941 | 1.0008 | 1.0114  | 1.0114  |
| March     | 0.9899   | 0.9951  | 0.9993 | 1.0042 | 1.0117  | 1.0117  |
| April     | 0.9916   | 0.9943  | 0.9965 | 1.0003 | 1.0047  | 1.0047  |
| May       | 1.0071   | 0.9994  | 1.0022 | 1.0022 | 0.9991  | 0.9991  |
| June      | 1.0127   | 1.0056  | 1.0028 | 0.9999 | 0.9977  |         |
| July      | 1.0135   | 1.0110  | 1.0041 | 1.0003 | 0.9960  | 0.9960  |
| August    | 1.0096   | 1.0087  | 1.0062 | 0.9937 | 0.9934  | 0.9934  |
| September | 1.0023   | 0.9964  | 1.0002 | 0.9962 | 0.9923  | 0.9923  |
| October   | 0.9995   | 0.9883  | 0.9945 | 0.9945 | 0.9965  | 0.9965  |
| November  | 0.9975   | 0.9942  | 0.9936 | 0.9974 | 0.9949  | 0.9949  |
| December  | 0.9968   | 0.9962  | 0.9958 | 1.0019 | 0.9988  |         |

**Table 2.C.2**  
**Latitudinal Correction Factors**

| Latitude | Factor | Latitude | Factor |
|----------|--------|----------|--------|
| 90°S     | 1.0386 | 90°N     | 0.9523 |
| 80°S     | 1.0380 | 80°N     | 0.9568 |
| 70°S     | 1.0367 | 70°N     | 0.9613 |
| 60°S     | 1.0354 | 60°N     | 0.9658 |
| 50°S     | 1.0347 | 50°N     | 0.9704 |
| 40°S     | 1.0334 | 40°N     | 0.9750 |
| 30°S     | 1.0327 | 30°N     | 0.9820 |
| 20°S     | 1.0314 | 20°N     | 0.9945 |
| 10°S     | 1.0308 | 10°N     | 1.0067 |
| 0°       | 1.0205 |          |        |

**Table 2.D.1**  
**Seasonally & Globally Corrected Monthly Mean CH<sub>4</sub> Concentrations**

| Month     | Year | Month # | Concentration (ppmv) | Hemisphere           | Reference                |
|-----------|------|---------|----------------------|----------------------|--------------------------|
| April     | 1965 | 4       | 1.5533               | N                    | Bainbridge&Heidt (1966)  |
| July      | 1965 | 7       | 1.5794               | N                    | "                        |
| September | 1967 | 33      | 1.4246               | N                    | Cavanaugh et al. (1969)  |
| March     | 1968 | 39      | 1.3668               | N                    | Stephens&Burleson (1969) |
| April     | 1968 | 40      | 1.3378               | N                    | Stephens (1984)          |
| June      | 1968 | 42      | 1.2255               | N                    | Swinnerton et al. (1969) |
| December  | 1968 | 48      | 1.4472               | N                    | Stephens (1984)          |
| March     | 1969 | 51      | 1.3938               | N                    | "                        |
| May       | 1969 | 53      | 1.3624               | N                    | "                        |
| May       | 1970 | 65      | 1.2936               | N                    | Lamontagne et al. (1973) |
| June      | 1970 | 66      | 1.3639               | N                    | "                        |
| May       | 1971 | 77      | 1.3519               | N                    | "                        |
| August    | 1971 | 80      | 1.3455               | N                    | "                        |
| August    | 1971 | 80      | 1.3615               | N                    | Larson et al. (1972)     |
| August    | 1971 | 80      | 1.2631               | N                    | Wilkniss et al. (1973)   |
| December  | 1972 | 96      | 1.4018               | N:1.4206<br>S:1.3831 | Lamontagne et al.(1974)  |
| January   | 1974 | 109     | 1.4994               | N                    | Wilkniss et al. (1975)   |
| September | 1974 | 117     | 1.5315               | N                    | "                        |

| Month     | Year | Month # | Concentration (ppmv) | Hemisphere           | Reference            |
|-----------|------|---------|----------------------|----------------------|----------------------|
| April     | 1974 | 124     | 1.4014               | N                    | "                    |
| November  | 1976 | 143     | 1.6246               | N                    | Seiler (1978)        |
| December  | 1976 | 144     | 1.6880               | N                    | "                    |
| June      | 1977 | 150     | 1.6098               | N                    | Fabian et al. (1981) |
| September | 1977 | 153     | 1.6164               | N                    | "                    |
| September | 1977 | 153     | 1.4265               | N:1.4764<br>S:1.4067 | Singh et al. (1979)  |
| November  | 1977 | 155     | 1.4386               | N:1.4069<br>S:1.4444 | "                    |
| November  | 1977 | 155     | 1.5222               | N                    | Blake et al. (1982)  |
| November  | 1977 | 155     | 1.5202               | N                    | Mayer et al. (1982)  |
| January   | 1978 | 157     | 1.5236               | N:1.5387<br>S:1.5086 | Blake et al. (1982)  |
| January   | 1978 | 157     | 1.5218               | N:1.5329<br>S:1.5202 | Mayer et al. (1982)  |
| February  | 1978 | 158     | 1.5434               | N                    | "                    |
| May       | 1978 | 161     | 1.6740               | N:1.6820<br>S:1.6661 | Heidt et al. (1980)  |
| June      | 1978 | 162     | 1.5686               | N                    | Fabian et al. (1981) |
| August    | 1978 | 164     | 1.5510               | N:1.5676<br>S:1.5343 | Mayer et al. (1982)  |
| September | 1978 | 165     | 1.5296               | S                    | "                    |
| April     | 1979 | 172     | 1.5519               | N                    | Mayer et al. (1982)  |
| May       | 1979 | 173     | 1.5602               | S                    | "                    |

| Month    | Year | Month # | Concentration (ppmv) | Hemisphere           | Reference             |
|----------|------|---------|----------------------|----------------------|-----------------------|
| May      | 1979 | 173     | 1.5700               | N                    | Newell et al. (1981)  |
| June     | 1979 | 174     | 1.5637               | N:1.5716<br>S:1.5557 | Blake et al. (1982)   |
| June     | 1979 | 174     | 1.5772               | N                    | "                     |
| June     | 1979 | 174     | 1.6284               | N                    | Fabian et al. (1981)  |
| June     | 1979 | 174     | 1.5775               | N:1.5711<br>S:1.5831 | Mayer et al. (1982)   |
| June     | 1979 | 174     | 1.6203               | N                    |                       |
| July     | 1979 | 175     | 1.5786               | N                    | Mayer et al. (1982)   |
| January  | 1980 | 181     | 1.5661               | N:1.5848<br>S:1.5474 | Blake et al. (1982)   |
| February | 1980 | 182     | 1.5642               | N                    | "                     |
| February | 1980 | 182     | 1.5248               | N                    | Leifer et al. (1981)  |
| March    | 1980 | 183     | 1.5613               | N                    | Cronn&Nutmagul (1982) |
| April    | 1980 | 184     | 1.5613               | N                    | "                     |
| May      | 1980 | 185     | 1.5507               | N                    | "                     |
| May      | 1980 | 185     | 1.5638               | N                    | Leifer et al. (1981)  |
| May      | 1980 | 185     | 1.5840               | N:1.5898<br>S:1.5753 | Blake et al. (1982)   |
| May      | 1980 | 185     | 1.6117               | N                    | "                     |
| May      | 1980 | 185     | 1.3960               | N                    | Stevens&Rust (1982)   |
| June     | 1980 | 186     | 1.652                | N                    | "                     |
| July     | 1980 | 187     | 1.6683               | N                    | "                     |
| August   | 1980 | 188     | 1.5793               | N:1.5873             | Blake et al. (1982)   |

| Month    | Year | Month # | Concentration (ppmv) | Hemisphere           | Reference                  |
|----------|------|---------|----------------------|----------------------|----------------------------|
|          |      |         |                      | S:1.5740             |                            |
| August   | 1980 | 188     | 1.5914               | N                    | "                          |
| October  | 1980 | 190     | 1.6378               | N                    | CoferIII (1982)            |
| November | 1980 | 191     | 1.5712               | N:1.5803<br>S:1.5621 | Blake et al. (1982)        |
| November | 1980 | 191     | 1.5966               | N                    | "                          |
| November | 1981 | 203     | 1.5840               | N:1.5969<br>S:1.5667 | Singh & Salas (1982)       |
| August   | 1975 | 128     | 1.4619               | N                    | Rasmussen & Khalil (1981b) |
| January  | 1976 | 133     | 1.4723               | N                    | "                          |
| June     | 1977 | 150     | 1.5357               | N                    | "                          |
| April    | 1978 | 160     | 1.4798               | N                    | "                          |
| October  | 1978 | 166     | 1.5458               | N                    | "                          |
| November | 1978 | 167     | 1.5598               | N                    | "                          |
| January  | 1979 | 169     | 1.5864               | N                    | "                          |
| February | 1979 | 170     | 1.5652               | N                    | "                          |
| April    | 1979 | 172     | 1.5629               | N                    | "                          |
| May      | 1979 | 173     | 1.5602               | N                    | "                          |
| August   | 1979 | 176     | 1.5904               | N                    | "                          |
| October  | 1979 | 178     | 1.5785               | N                    | "                          |
| March    | 1980 | 183     | 1.6135               | N                    | "                          |
| April    | 1980 | 184     | 1.5977               | N                    | "                          |
| May      | 1980 | 185     | 1.5952               | N                    | "                          |



| Month     | Year | Month # | Concentration (ppmv) | Hemisphere | Reference            |
|-----------|------|---------|----------------------|------------|----------------------|
| June      | 1980 | 186     | 1.5943               | N          | "                    |
| November  | 1965 | 11      | 1.5231               | N          | Ehhalt&Heidt (1973)  |
| March     | 1966 | 15      | 1.4896               | N          | "                    |
| June      | 1966 | 18      | 1.3523               | N          | "                    |
| July      | 1966 | 19      | 1.2532               | N          | Ehhalt (1967)        |
| September | 1966 | 21      | 1.6662               | N          | "                    |
| September | 1966 | 21      | 1.7595               | N          | Ehhalt&Heidt (1973)  |
| November  | 1966 | 23      | 1.3602               | N          | "                    |
| June      | 1971 | 78      | 1.5704               | N          | Ehhalt (1978)        |
| July      | 1971 | 79      | 1.8019               | N          | "                    |
| August    | 1971 | 80      | 1.5381               | N          | Ehhalt et al. (1983) |
| February  | 1972 | 86      | 1.5288               | N          | "                    |
| September | 1972 | 93      | 1.5697               | N          | "                    |
| November  | 1972 | 95      | 1.7354               | N          | "                    |
| March     | 1973 | 99      | 1.6979               | N          | "                    |
| February  | 1974 | 110     | 1.5798               | N          | "                    |
| May       | 1974 | 113     | 1.5778               | N          | "                    |

**Table 2.D.2**  
**Summary of Trends**

| Group# | Description                         | Number of Observations | Period  | Trend (% per year) | r     |
|--------|-------------------------------------|------------------------|---------|--------------------|-------|
| (i)    | All GC                              | 93                     | 1965-81 | 0.62±0.14          | 0.414 |
|        | Yearly ave.                         | 17                     | 1965-81 | 0.66±0.27          | 0.524 |
| (ii)   | Rasmussen's                         | 16                     | 1975-81 | 1.91±0.21          | 0.915 |
|        | Ehhalt's                            | 16                     | 1965-74 | 1.05±0.70          | 0.353 |
|        | Rest of GC                          | 61                     | 1965-81 | 1.06±0.15          | 0.678 |
| (iii)  | N. Hemisphere                       | 49                     | 1977-81 | 1.28±0.44          | 0.384 |
|        | S. Hemisphere                       | 16                     | 1977-81 | 1.50±0.70          | 0.483 |
| (iv)   | Rest of GC&Rasmussen's              | 77                     | 1965-81 | 1.04±0.13          | 0.695 |
|        | Rest of GC&Ehhalt's                 | 77                     | 1965-81 | 0.62±0.16          | 0.395 |
|        | Rest of GC& Ehhalt's unrevised data | 93                     | 1965-81 | 1.37±0.13          | 0.751 |

r = correlation coefficient

**Table 2.D.3**  
**Summary of Trends**  
**(Non-parametric Theil tests)**

| Group# | Description                            | Period  | Trend<br>(% per year) | $\beta_L$ | $\beta_U$ |
|--------|--|---------|-----------------------|-----------|-----------|
| (i)    | All GC                                 | 1965-81 | 0.94                  | 0.54      | 1.20      |
|        | Yearly ave.                            | 1965-81 | 0.70                  | 0.06      | 1.36      |
| (ii)   | Rasmussen's                            | 1975-81 | 1.87                  | 1.54      | 2.34      |
|        | Ehhalt's                               | 1965-74 | 1.21                  | -0.92     | 3.16      |
|        | Rest of GC                             | 1965-81 | 1.22                  | 0.79      | 1.50      |
| (iii)  | N. Hemisphere                          | 1977-81 | 1.37                  | 0.84      | 1.98      |
|        | S. Hemisphere                          | 1977-81 | 1.22                  | -0.34     | 2.96      |
| (iv)   | Rest of GC&Rasmussen's                 | 1965-81 | 1.26                  | 0.93      | 1.52      |
|        | Rest of GC&Ehhalt's                    | 1965-81 | 0.75                  | 0.33      | 1.10      |
|        | Rest of GC& Ehhalt's<br>unrevised data | 1965-81 | 1.49                  | 1.24      | 1.72      |

r = correlation coefficient  
 $\beta_L$  and  $\beta_U$  are lower and upper 90% Confidence limits.

### 3. Systematic Methane Measurements

#### 3.A Introduction:

An attempt to carry out seasonal variation studies and trend analyses of atmospheric methane data of the 60s and early 70s exposed the deficiencies of the available information and generated a demand for long term continuous or systematic databases. The outcome was a series of intensive methane measurements carried out by a few related groups of researchers (Rasmussen and Khalil, 1981a, b, 1983; Fraser et al., 1981; Steele et al., 1983). These groups concentrated on studying seasonal variations and trends of methane at selected sites over long periods. Rasmussen and Khalil obtained the most extensive data base of the three; the work is still continuing. The focus of this chapter is a review and analyses of this database and the other two from published literature. In the next section, a review of the papers of the three groups, closely examining the salient features of their results, is presented. A trend study of Rasmussen and Khalil, and Fraser et al.s measurements, made until 1984, is given next. As a comparison between the results of dependent and independent groups, Blake et al.s (1982) methane measurements have analyzed for trend, even though these data do not strictly conform to a systematic set. The chapter concludes with the results from continuous methane observations.

### 3.B A Review:

Rasmussen and Khalil (1981a) first reported more than 16000 measurements of atmospheric methane concentration spanning a period of nearly two years. The observations were made at a remote location on Oregon coast (Cape Meares, 45°N). A modified Carle 211-MS gas chromatograph equipped with a flame ionization detector (GC/FID) was used to make the measurements which started in 1979. The data was electronically processed and stored on magnetic tapes. The automatic system samples air every twenty minutes round the year. Figure 3.B.1 presents a schematic view of the gas handling system at Cape Meares. The authors report that their system is optimized to measure  $CH_4$  around 1.5ppmv (precision <0.7%) and that the absolute accuracy of methane analysis is about  $\pm 5\%$  based on commercially available standards. The authors in their subsequent paper (Rasmussen and Khalil, 1981b) report a more elaborate trend analysis of the 22 months of  $CH_4$  data collected in 1979-80. Rasmussen and Khalil show that methane increased at a rate of  $1.9 \pm 0.5\%$  per year during the course of their study. Khalil and Rasmussen (1982) analyzed methane measurements specifically for trends. They report methane trend of 1.2 to 1.9% per year from a group of methane data bases that were available at that time. A more recent study (Rasmussen and Khalil, 1983) examines the extensive global measurements of methane made over a period of four years starting with 1978. The authors found a methane increase of 1.4% per year over this period from seven stations where systematic concentration measurements were made. The data from this paper are presented in Table 3.B.1.

Fraser et al. (1981) analyzed methane data from Southern hemisphere for trends. 26 large and 72 small volume air samples were collected at Cape Grim, Tasmania (41°S) spanning eleven months of a three year period starting with April, 1978. Methane concentrations in the samples were measured on a gas chromatograph equipped with a flame ionization detector (GC/FID). The authors applied a linear model ( $C=a+bt$ ) which revealed that the methane increase over the sampling period (39 months) to be  $1.2\pm 0.3\%$  per year. By comparing  $CH_4$  measurements made at Cape Meares (Rasmussen and Khalil, 1981b) during the years 1980-81, the authors found slightly higher methane rate of increase ( $1.9\pm 0.4\%$ ) in the latter case. The authors also report that when both the data sets are compared in the same time frame (1980-81), the computed trends turn out to be insignificantly different. Fraser et al. (1984) reported surface observations of methane concentrations made during the period September 1980 - March 1983 at Cape Grim. The flask samples at Cape Grim site were collected on a weekly basis under wind conditions when trajectory analyses had indicated air parcels of clean marine origin. The  $CH_4$  analyses were carried out on a GC/FID equipment described in the previous paper (Fraser et al., 1981). The authors determined long term trends by fitting a function of the form:

$$C = a + bt + c \sin 2\pi t / T_n$$

where  $C$  is the measured atmospheric  $CH_4$  mixing ratio;  $a$ ,  $b$ , and  $c$  are coefficients of the function;  $T_n$  is the period of  $n$ th cycle; and  $t$  is the time in years. The rate of increase of methane  $\beta$  ( $=b$ ) computed from about 400 measurements made at Cape Grim was  $1.1\pm 0.1\%$  per year. The authors indicate that their results are identical to earlier findings (Rasmussen and Khalil, 1981b) on systematic methane

data. A continued and expanded  $CH_4$  measurements in the Southern hemisphere is reported recently by Fraser et al. (1985). Surface level samples were collected at Cape Grim and Mawson, Antarctica (68°S). Methane measurements were made using the GC system and calibration procedures narrated before. The authors report an annual  $CH_4$  increase of  $1.15 \pm 0.04\%$  per year at both locations for 1984. The authors also note that there is no significant difference in  $CH_4$  levels observed at these two sites which is consistent with previous observations of non varying methane mixing ratios throughout the mid -to- high latitudes of the Southern hemisphere (Ehhalt et al., 1978; Fraser et al., 1984). The complete set of data for each of the stations is presented in Tables 3.B.2, and 3.B.3 respectively.

A joint effort among CSIRO, NOAA/GMCC, and OGC initiated a program to measure methane at NOAA/GMCC's existing global network of over 20 stations (Steele et al., 1983). Weekly air samples collected at these sites were analyzed for  $CH_4$  and  $CO_2$  using GC/FID system. This data base for the period 1983-84 has been used in the calculation of global indices presented in the previous chapter. The data and more information on sampling protocol, GC/FID gas sampling system, and annual methane variability can be found in Steele et al. s forthcoming paper (1985).

### **3.C Trend Analysis:**

Rasmussen and Khalil's (1983) continuous measurements have been subjected to a variety of analyses dealing with interhemispheric gradients, seasonal variations, and trend studies. The results of these investigations can be found in

the authors' previously mentioned papers. A more recent publication (Khalil and Rasmussen, 1985c) deals with methane measurements made at Cape Meares, Oregon upto the end of 1984. A longterm methane increase of about 1% per year can be observed from this longer set of data. The data are presented in Figure 3.C.1.

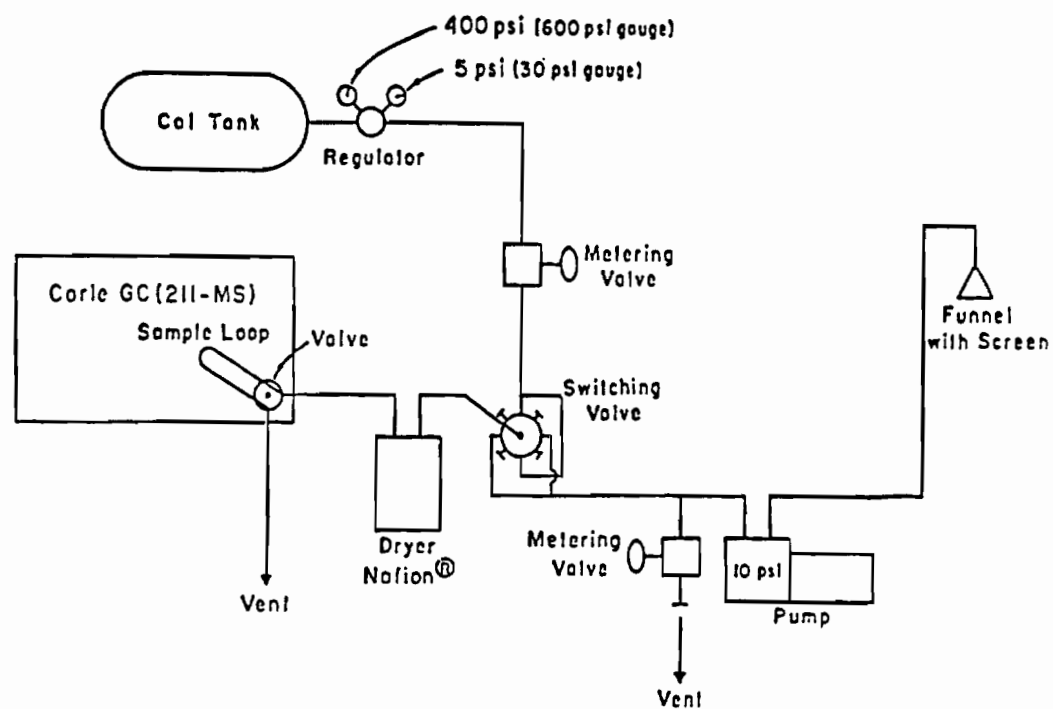
Fraser et al.s (1985) methane observations from Cape Grim and Mawson sites were analyzed for trends in the same time frame from August, 1980 to December, 1984. First all the measurements are corrected for seasonal variations using the seasonal indices given in the previous chapter. Linear regression of the corrected data, performed on each data set, yield annual methane increases of  $1.208 \pm 0.593\%$ ,  $1.208 \pm 0.574\%$  per year respectively. The results are presented in graphical form in Figures 3.C.2, and 3.C.3. The agreement between these results and Fraser's results (using a cyclic trend model) are excellent.

Blake et al.'s (1982)  $CH_4$  measurements span a period of three years starting with November 1977. A review of the paper is presented in Chapter 2. Seasonally and globally corrected data from this paper (see Table 2.D.1) has been analyzed for trends. Linear regression of the observations show an annual methane increase of 1.5%. The results from this independent group is in excellent agreement with the dependent group results reported before. Figure 3.C.4 presents a graphical view of this trend study.

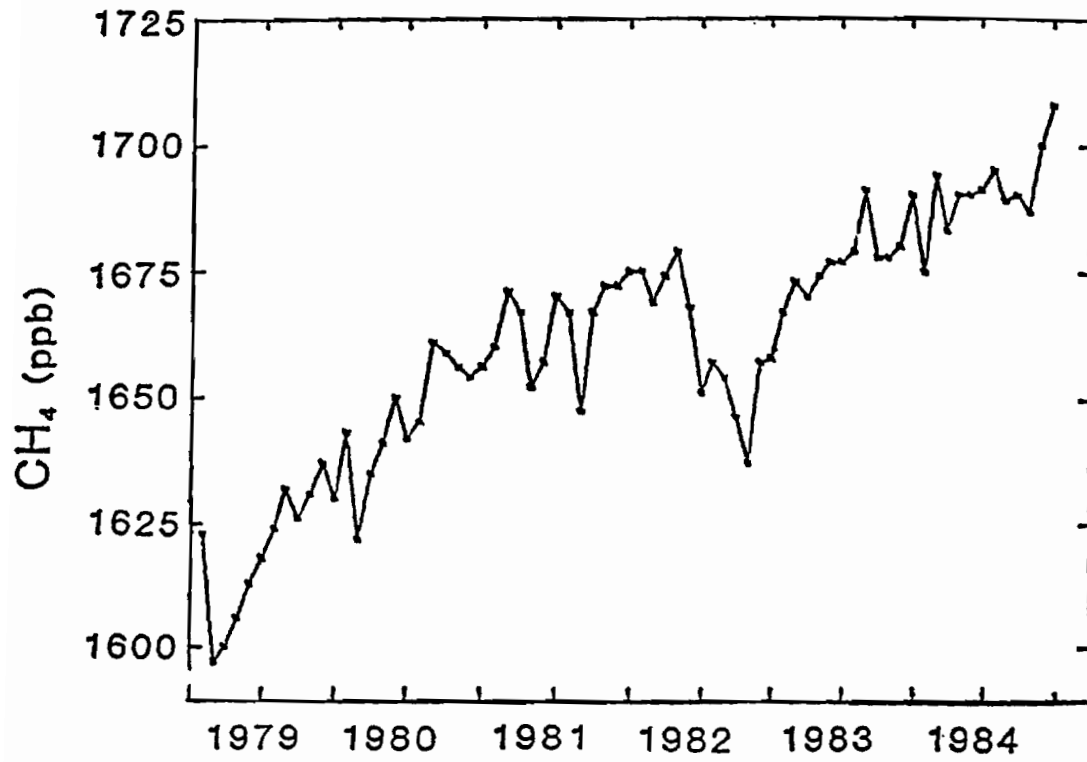


**3.D Conclusions:**

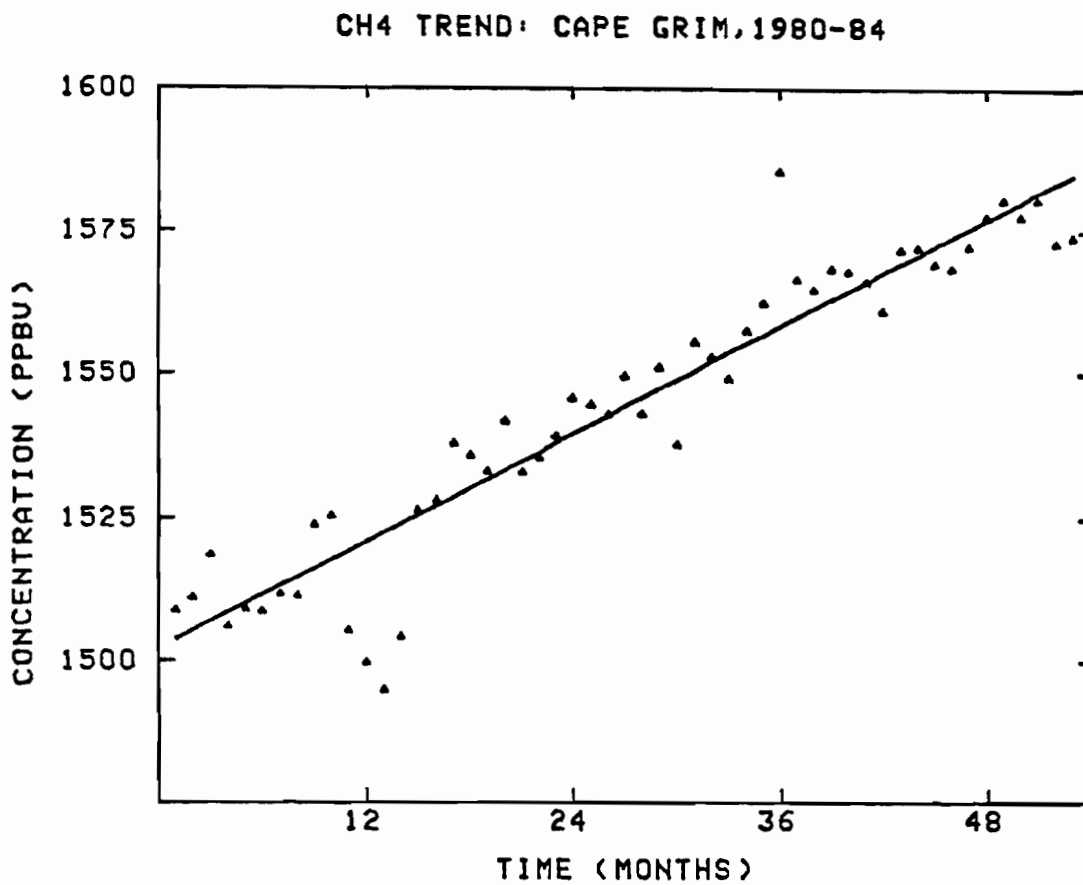
The systematic measurements, made in recent years, lend a solid support to the theory of increasing atmospheric methane. The three  $CH_4$  data bases analyzed in this chapter consolidate the view that atmospheric methane is increasing at an annual rate of about 1% per year.



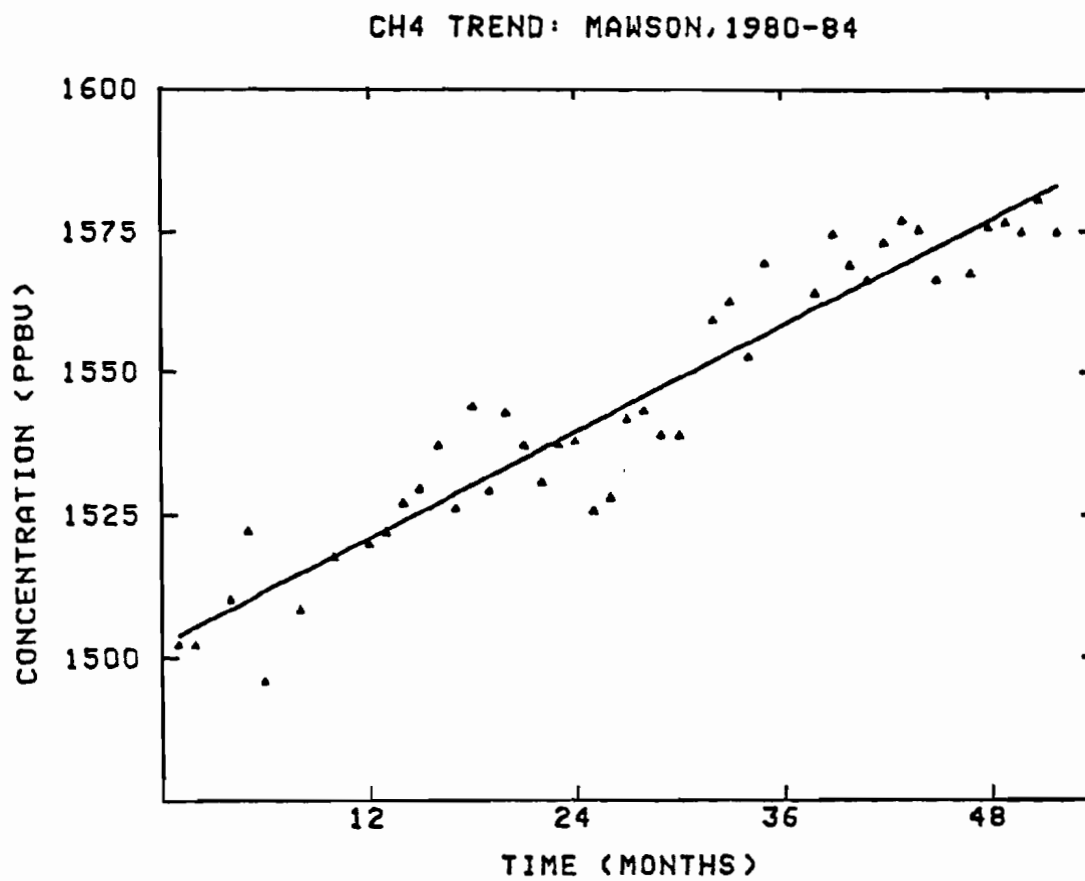
**Figure 3.B.1** Figure shows schematic view of the automatic gas handling system at Cape Meares, Oregon.



**Figure 3.C.1** Plot of monthly methane concentrations from Cape Meares, Oregon (Khalil and Rasmussen, 1985c) upto the end of 1984.



**Figure 3.C.2** A trend analysis of methane concentrations from Cape Grim, Tasmania (Fraser et al., 1985). The plot shows linear regression line with a slope of  $\approx 1.2\% \text{CH}_4/\text{year}$



**Figure 3.C.3** A trend analysis of methane concentrations from Mawson, Antarctica (Fraser et al., 1985). The plot shows linear regression line with a slope of  $\approx 1.2\% \text{CH}_4/\text{year}$

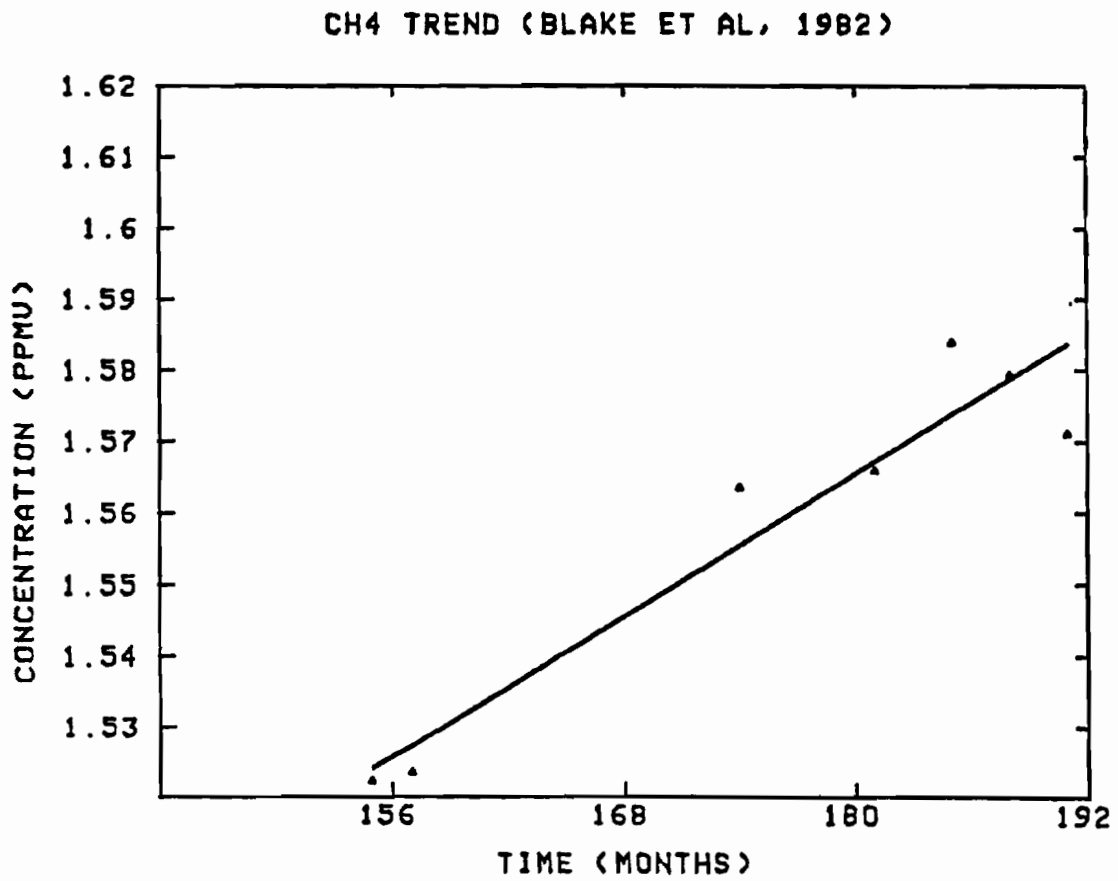


Figure 3.C.4 Plot shows a linear regression of Blake et al.'s (1982) measurements spanning a period of about three years.

Table 3.B.1

## Monthly Average Methane Concentrations (Rasmussen &amp; Khalil, 1983)

| Month     | Year | $CH_4$ Concentration (ppbv) |                       |                     |                         |                 |
|-----------|------|-----------------------------|-----------------------|---------------------|-------------------------|-----------------|
|           |      | Barrow<br>(71°N)            | Cape Meares<br>(45°N) | Mauna Loa<br>(20°N) | Cape Kumukahi<br>(20°N) | Samoa<br>(14°S) |
| January   | 1979 | -                           | 1619                  | -                   | -                       | -               |
| February  | "    | -                           | 1619                  | -                   | -                       | -               |
| March     | "    | -                           | 1608                  | -                   | -                       | -               |
| April     | "    | -                           | 1615                  | -                   | -                       | -               |
| May       | "    | -                           | 1614                  | -                   | -                       | -               |
| June      | "    | -                           | 1609                  | -                   | -                       | -               |
| July      | "    | -                           | 1597                  | -                   | -                       | -               |
| August    | "    | -                           | 1618                  | -                   | -                       | -               |
| September | "    | -                           | 1632                  | -                   | -                       | -               |
| October   | "    | -                           | 1650                  | -                   | -                       | -               |
| November  | "    | -                           | 1647                  | -                   | 1588                    | -               |
| December  | "    | -                           | 1636                  | -                   | 1586                    | -               |
| January   | 1980 | -                           | 1639                  | -                   | 1603                    | -               |
| February  | "    | -                           | 1621                  | -                   | 1568                    | -               |
| March     | "    | -                           | 1643                  | -                   | 1612                    | -               |
| April     | "    | -                           | 1650                  | -                   | 1586                    | -               |
| May       | "    | -                           | 1651                  | -                   | 1606                    | -               |
| June      | "    | -                           | 1633                  | -                   | -                       | 1541            |

| Month     | Year | <i>CH</i> <sub>4</sub> Concentration (ppbv) |                       |                     |                         |                 |
|-----------|------|---|-----------------------|---------------------|-------------------------|-----------------|
|           |      | Barrow<br>(71°N)                            | Cape Meares<br>(45°N) | Mauna Loa<br>(20°N) | Cape Kumukahi<br>(20°N) | Samoa<br>(14°S) |
| July      | "    | -   | 1627                  | -                   | -                       | 1542            |
| August    | "    | 1628  | 1647                  | -                   | 1554                    | 1520            |
| September | "    | 1644  | 1665                  | -                   | 1569                    | 1518            |
| October   | "    | 1658  | 1676                  | -                   | 1603                    | 1519            |
| November  | "    | 1655  | 1664                  | -                   | 1591                    | 1513            |
| December  | "    | 1661  | 1662                  | -                   | 1579                    | 1524            |
| January   | 1981 | 1656  | 1656                  | -                   | 1588                    | -               |
| February  | "    | 1667  | 1670                  | 1582                | 1581                    | 1522            |
| March     | "    | 1647  | 1675                  | 1571                | 1602                    | 1521            |
| April     | "    | 1650  | 1661                  | 1580                | 1599                    | 1522            |
| May       | "    | 1641  | 1658                  | 1581                | 1593                    | 1515            |
| June      | "    | 1626  | 1638                  | 1542                | 1579                    | 1515            |
| July      | "    | 1628  | 1626                  | 1551                | 1574                    | 1517            |
| August    | "    | 1638  | 1622                  | 1569                | 1587                    | 1535            |
| September | "    | 1653  | 1673                  | 1587                | 1596                    | 1546            |
| October   | "    | 1663  | 1692                  | 1596                | 1600                    | 1545            |
| November  | "    | 1681  | 1682                  | -                   | -                       | 1544            |
| December  | "    | 1691  | 1681                  | 1598                | 1610                    | 1546            |
| January   | 1982 | 1695  | -                     | 1592                | 1606                    | 1552            |
| February  | "    | 1727  | -                     | 1599                | 1591                    | 1556            |



| Month | Year | <i>CH<sub>4</sub></i> Concentration (ppbv) |                       |                     |                         |                 |
|-------|------|--|-----------------------|---------------------|-------------------------|-----------------|
|       |      | Barrow<br>(71°N)                           | Cape Meares<br>(45°N) | Mauna Loa<br>(20°N) | Cape Kumukahi<br>(20°N) | Samoa<br>(14°S) |
| March | "    | 1701                                       | -                     | 1599                | 1613                    | 1544            |
| April | "    | 1695                                       | -                     | 1611                | 1623                    | 1542            |
| May   | "    | 1680                                       | -                     | 1603                | 1628                    | 1551            |
| June  | "    | 1673                                       | -                     | 1596                | -                       | 1544            |

**Table 3.B.2**  
**Monthly mean Methane Concentrations**  
**Cape Grim, Tasmania (Fraser et al., 1985)**

| Month     | $CH_4$ Concentration (ppbv) |      |      |      |      |      |      |
|-----------|-----------------------------|------|------|------|------|------|------|
|           | 1978                        | 1979 | 1980 | 1981 | 1982 | 1983 | 1984 |
| January   | -                           | -    | -    | 1508 | 1535 | 1537 | 1560 |
| February  | -                           | 1465 | 1489 | 1495 | 1516 | 1538 | 1554 |
| March     | -                           | -    | -    | 1494 | 1524 | 1535 | 1554 |
| April     | 1459                        | -    | -    | 1517 | 1526 | 1542 | 1562 |
| May       | -                           | 1483 | -    | 1527 | 1537 | 1559 | 1570 |
| June      | -                           | -    | -    | 1509 | 1543 | 1566 | 1576 |
| July      | 1475                        | -    | -    | 1506 | 1552 | 1592 | 1584 |
| August    | -                           | -    | 1519 | 1505 | 1555 | 1577 | 1591 |
| September | -                           | -    | 1523 | 1516 | 1555 | 1577 | 1590 |
| October   | 1481                        | -    | 1524 | 1532 | 1555 | 1574 | 1586 |
| November  | -                           | 1495 | 1514 | 1536 | 1551 | 1576 | 1581 |
| December  | -                           | -    | 1511 | 1540 | 1553 | 1568 | 1576 |

Table 3.B.3

Monthly Mean Methane Concentrations  
Mawson, Antarctica (Fraser et al., 1985)

| Month     | $CH_4$ Concentration (ppbv) |      |      |      |      |
|-----------|-----------------------------|------|------|------|------|
|           | 1980                        | 1981 | 1982 | 1983 | 1984 |
| January   | -                           | 1495 | 1543 | 1538 | 1572 |
| February  | -                           | -    | 1512 | -    | 1559 |
| March     | 1487                        | 1491 | 1525 | 1541 | 1557 |
| April     | 1495                        | -    | 1530 | 1555 | 1559 |
| May       | -                           | 1519 | 1532 | 1554 | -    |
| June      | 1510                        | -    | 1541 | 1573 | 1571 |
| July      | -                           | 1526 | 1544 | -    | 1582 |
| August    | 1512                        | 1532 | 1536 | -    | 1587 |
| September | 1514                        | 1539 | 1540 | 1576 | 1587 |
| October   | -                           | 1535 | 1547 | 1580 | 1586 |
| November  | 1518                        | 1545 | 1551 | 1577 | 1583 |
| December  | 1524                        | 1528 | 1541 | 1568 | -    |

## 4. Methane Levels in Ancient Air

### 4.A Introduction:

One of the major objectives of the study of the gas enclosures in polar ice is a search for ancient air. When firn turns into ice through densification and recrystallization, a volume of atmospheric air is trapped in ice as the pores close off. The trapped air is preserved as bubbles inside ice as further layers of firn compact and accumulate. The idea of a correlation between the composition of the gas bubbles in polar ice cores and ancient atmosphere has been suggested (Scholander et al., 1961). Along this line a fairly large number of studies have been made, most of which are concentrated towards the major components of the atmosphere (Matsuo et al., 1966; Lorius et al., 1968; Raynaud et al., 1973). Robbins et al. (1973) extended the general idea to study methane concentrations in polar ice. In this chapter, a compilation of all the available information on methane measurements in polar ice cores is presented. A critical review of the data and trend analysis to establish the recent increase has also been carried out. As will soon become apparent, these studies are subject to a variety of difficulties, both theoretical and experimental.

### 4.B Compendium of Ice Core Data:

Methane is a less water soluble minor component of atmosphere found in gas bubbles of polar ice. The gas is also insoluble in ice or snow. Robbins et al. (1973)

first analyzed the gas in ice samples for methane. In 1967, ice samples from an inclined tunnel at Camp Century, Greenland were obtained below the firn line. Each sample of 50 pounds, taken from 8-12 inches deep from the tunnel walls, was shipped to Stanford Research Institute (SRI) for analyses. An ice handling system, developed at SRI was used to extract air from molten ice. Care was taken to eliminate external air by repetitive helium pressurization- evacuation cycles. The average air yield was 50ml(STP) per kilogram of ice sample. The extracted air was then analyzed for its methane content using gas chromatography. Similar analyses were also carried out on a set of samples from Byrd Station, Antarctica. The ice ages were in the range of 115 to 2500 years. The methane concentration range from 0.42 to 0.76 ppm and averaged 0.56 ppm. Carbon Monoxide content of the samples was also determined. The data set is presented in Table 4.B.1. The group of arctic data has consistently lower range than the concentrations measured by other workers whereas the antarctic measurements are in agreement with that of others. This indicates a possible systematic underestimation of North Pole concentrations as will be detailed later.

Khalil and Rasmussen (1982) investigated the  $CH_4$  concentrations in the unperturbed old atmosphere. The authors replicated Robbins et al.'s experiments with Greenland icecore. The measurements which form a part of Rasmussen and Khalil's (1984) larger icecore  $CH_4$  database indicate that human activities may already have doubled atmospheric methane levels.

Craig and Chou (1982) reported methane measurements from deep polar ice cores drilled in Southern Greenland. The 2035 meters Dye 3 core was drilled dur-

ing 1979-81. Ice samples weighing approximately 40g each were melted under vacuum to extract the air trapped in the bubbles. Freezing and extraction were repeated several times to insure complete recovery. The methane analyses were carried out on an FID Shimadzu gas chromatograph. The authors report a precision for methane better than  $\pm 1\%$  based on clean standards. Also the reported air content of  $93.8 \pm 7.3$  cc(STP)/kg of ice is in agreement with earlier predictions (Raynaud et al., 1979). The individual methane measurements made at depths from 82 to 1951 meters are presented as a part of Table 4.B.1. The authors report that the tabulated ages were obtained from oxygen isotope stratigraphy down to 225 meters and from ice flow equations below this depth. The measurements indicate a possible increasing trend in the recent past and a steady profile earlier. The linear increasing trend can be seen, from the data presented to have begun some 350 years ago. However the exact time when this increase begun needs further analyses and forms a part of the material presented in this chapter.

A more recent study (Rasmussen and Khalil, 1984) in the series of analysis of polar ice cores is designed towards getting a much clearer picture of the situation through a careful study of the ice cores collected. Rasmussen and Khalil analyzed both arctic (Crete; Camp Century) and antarctic (Byrd Station) ice cores obtained from the NSF ice core facility at the State University of New York(SUNY) at Buffalo. After removing the outer crust, small unfractured samples were prepared for analyses. Each sample was placed inside a stainless steel internally electropolished (*SUMMA*<sup>®</sup>) cylinder with Nupro bellow valves for sampling. The container was then flushed with nitrogen free helium, pressurized to 1000 Torr, and placed in a warm water bath which melted the ice core sample

inside. Dried air samples were analyzed for methane content when the sampling cylinder achieved thermal equilibrium with the surroundings. Care was taken to check the flushing efficiency. Methane was measured on a Carle 211-MS gas chromatograph equipped with a flame ionization detector, and a molecular sieve column. A Hewlett Packard 3390 was used to integrate the chromatographic peaks, which were also verified on a chart recorder. The authors report a precision of  $\pm 5\%$ . The multiple analyses on each core sample had a reproducibility of  $\pm 1\%$ . The measurements are presented in Table 4.B.1. A total of 41 measurements from arctic cores and 42 measurements from antarctic cores, reported in the authors' paper, span over a period of 3000 years. The age of the samples were compiled by C.C. Chou (Scripps) and the age of the air in bubbles was taken to be 90 years less than the age of the ice itself.

Stauffer et al. (1985) analyzed air entrapped in bubbles of South Pole ice core drilled at Siple Station ( $76^{\circ}\text{S}$ ). Seasonal variations of the electrical conductivity were used to date the ice core with an accuracy of about 2 years down to a depth of 144m. Air was extracted from the bubbles in ice samples by vacuum melt extraction (11 samples; 2 measurements each) and dry extraction (12 samples; 3-4 measurements each) methods. Methane content of the extracted gas was measured with a gas chromatograph HP5880A using flame ionization detector. The concentration data from the above mentioned samples and an older sample are given in Table 4.B.1. The authors report that their measurements agree well with Rasmussen and Khalil's (1984) measurements within experimental error.

#### 4.C A Critical Review:

Robbins et al. (1973) observed widely varying methane concentrations (0.37-0.57 ppm; 0.46-0.70 ppm) in their tunnel samples from Camp Century Site in Greenland. The authors reported a total gas content of  $\approx 50$  ml (STP) per kg of ice in these tunnel samples which is approximately one half of that measured in other extensive studies (Raynaud et al., 1973; Raynaud et al., 1979; Craig et al., 1982; see also figure 4.C.1).  $C^{14}$  and  $O^{18}$  determinations on the ice of greatest age from Greenland had a relatively low variability in gas composition in 23 of the 25 samples analyzed (Scholander et al., 1961). Another possibility to be considered, to examine Robbins et al.'s lower measurements, is the change of methane content of the bubbles through the gain or loss of the gas by diffusion. However, low permeation constants for most gases (for eg:  $\approx 1 \times 10^{-12}$  cm<sup>2</sup>/sec for CO<sub>2</sub> - Hemmingsen, 1959) preclude any such possibility. Lorius et al (1968), in their investigation of a 100m ice core from coastal region of Terre Adelie (Antarctica), found a total gas content of approximately 4cm<sup>3</sup>/100g in the samples which were contaminated by morainic debris. The Robbins et al. also propose a hypothesis of methane conversion to CO inside the air bubbles in ice because of the higher observed CO concentrations. A careful investigation of methane and carbon monoxide concentrations in snow (Rasmussen et al., 1982) revealed that snow gives off large amounts of CO when melted. A similar phenomena (with other gases) observed by Scholander et al. (1961) was ascribed to the possible melt water freeze out process at the firn stage. Bacterial activity catalyzing the oxidation of methane to CO is ruled out for metabolic functions of bacteria are severely arrested in the absence of liquid



water at cold temperatures. Craig and Chou (1982) observed that Robbins et al.'s Greenland measurements were lower than other measurements of the same ice age. These results logically lead to the conclusion that the Greenland  $CH_4$  measurements of the authors may not represent atmospheric concentrations of the quoted age and hence have not been included in the analyses presented in the next section.

Before firn turns into ice, it is permeable to air. The result of this mixing is that the air trapped in bubbles is much younger than the ice. As a first approximation, this age difference is taken to be about 90 years. Schwander and Stauffer (1984) experimentally verified this age difference to be 95 years for ice core from Siple Station. Also they estimate this age difference, through a semiempirical formula, to be different for different locations. However the large range of this estimated age difference (eg: 90 years for Dye 3 core - 2800 years for Vostok core) and the uncertainties in air mixing during the firn stage limit the applicability of this theoretical procedure at this time. The correction of Rasmussen and Khalil's data using revised age estimates did not yield results that were statistically different (Stauffer et al., 1985). Hence a consistent value of 90 years is adopted as the difference in age between the ice and air in the bubbles. Also variations of firn to ice transition time are less important for older samples that have ages of several hundred years.

#### **4.D Trend Analysis of Ice Core Data:**

The primary goals of the analysis of methane concentration record in ice

cores is to detect the trend and the period during which the recent rapid rise, as observed in the atmospheric measurements, has started. Rasmussen and Khalil (1982) estimated the start of this period to about 200 years ago from the analysis of their arctic and antarctic database. Craig and Chou (1982) carried out a similar study but with a smaller set of data which showed the rise to have begun about 400 years ago. Rasmussen and Khalil (1984) studied the critical period of last few centuries and concluded that the rapid rise and doubling of methane levels were a recent phenomena starting about 150 years ago. Ice core studies of methane that were reported so far had been done on an individual basis without much analysis of the combined data base. Also new studies (for example, Stauffer et al., 1985) provided enough measurements such that pooling of data could be done without absolute differences adversely influencing the analyses. The aim of this investigation is to analyze the composite and larger database available today, and establish the period during which the rapid  $CH_4$  rise started. Figure 4.D.1 presents all the ice core methane measurements that have been published so far. A look at the plot shows that the increasing methane trend is a recent phenomena. To facilitate a better view, the figure 4.D.2 shows the data that goes back to 1000 A.D. from the present. It is clearly seen from this graph that the region of interest spans a period of last 500 years when there is slow increase in methane concentrations followed by a rapid rise. Accordingly trend analysis of data has been confined to this time period.

The rate of increase of methane is calculated for each overlapping period of 100 years, starting with 1450 A.D., using the model (Rasmussen and Khalil, 1984),

$$\beta = \frac{1}{C} \frac{dC}{dt}$$

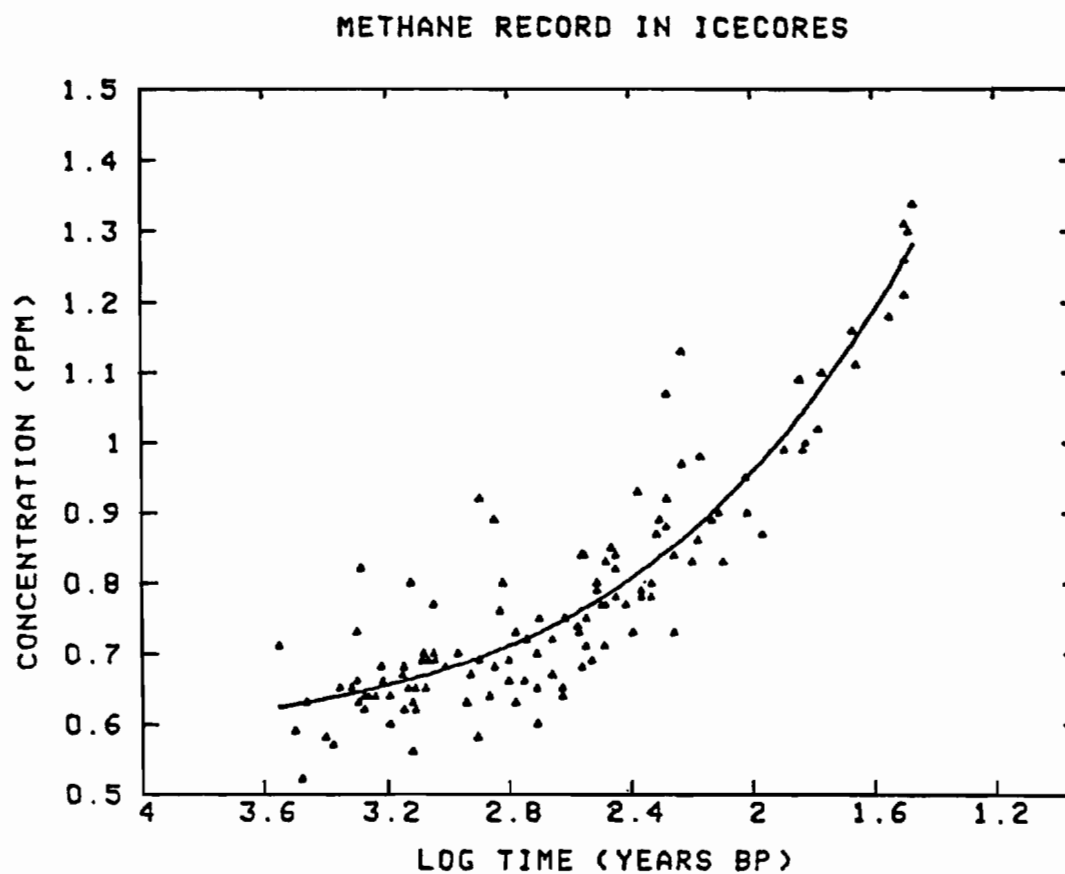
$$C = \frac{1}{2}(C_i + C_{i+1}) \quad i=1,2,3,\dots$$

where  $\beta$  is the relative rate of increase. Each set is taken to be a student t-distribution with a sample mean of  $C$ . The results of the computation are presented in Table 4.D.1. Approximate 90% confidence limits for  $\beta$  computed from that of  $C$  are also given in this table. Figure 4.D.3 shows the plot of the results from this analysis along with the confidence limits. The rapid rise started in the early nineteenth century or about 150 years ago. The years earlier experienced a slower and variable methane increase. This study shows that the ice core data can be effectively used to decipher the exact time of the rapid rise observed today. A comparison with population growth indicates that most of this increase may have been due to human activities, including agriculture, cattle raising and the use of petroleum oriented products (see also Khalil and Rasmussen, 1985a).

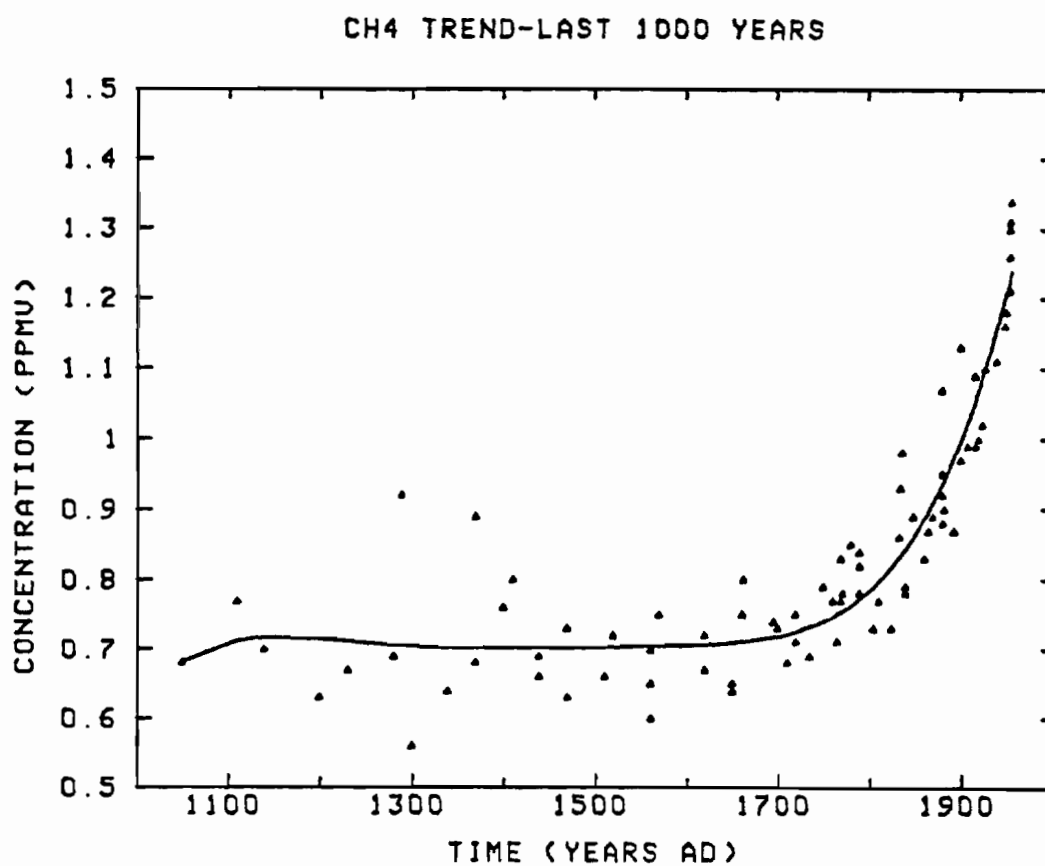
Rasmussen and Khalil (1984) and Stauffer et al. (1985) each have a set of data that overlap in time scale in the period 1700-1900 A.D. This enables a close examination of the agreement of measurements of these two investigators. For this purpose, Rasmussen and Khalil's (1984) methane measurements in North Pole are adjusted to South Pole levels by multiplying with calculated interhemispheric ratios of 1.07-1.11 (see Rasmussen and Khalil, 1984). The adjusted sets are then compared with Stauffer et al.'s South Pole measurements. The data sets and the linear regression line of each of the sets are presented in figure 4.D.4. The comparison shows that the measurements of the two groups are in excellent agreement within experimental errors.

#### 4.E Conclusions:

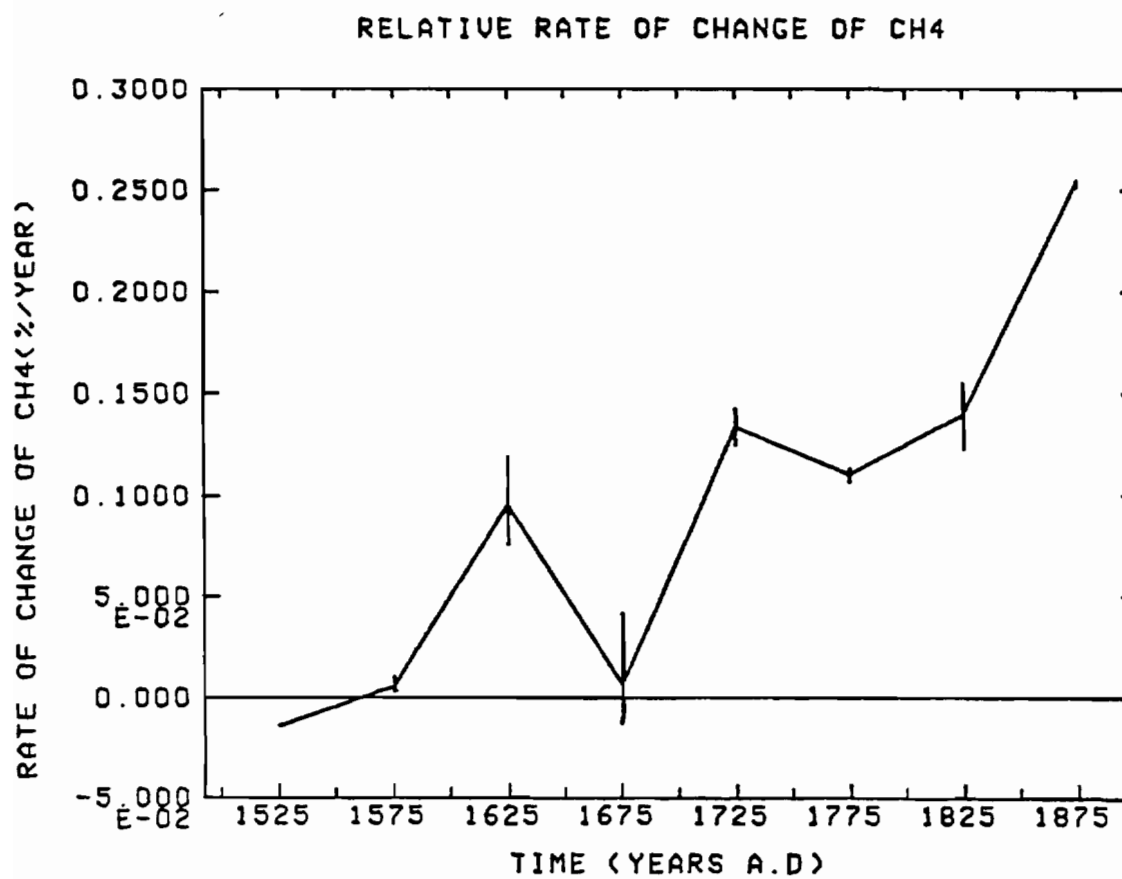
In this chapter sets of methane data from ice core collected by four different groups have been analyzed to determine the period during which the recent rapid rise has started. Trend analysis shows that the recent increase began about 150 years ago. Consistency of two groups of data (Rasmussen and Khalil, and Stauffer et al.) also was found to be excellent in the critical period of past two centuries. Also the doubling of methane concentrations occurred during this period (from  $\approx 0.70$  ppm to  $\approx 1.40$  ppm). The findings show that the measured concentrations of methane reflect that of the atmospheric levels existing in the past. The ages of the ice and the air in bubbles are subject to some uncertainties. However, the analyses support the general idea, within experimental error, that the rise of methane started in the recent past.



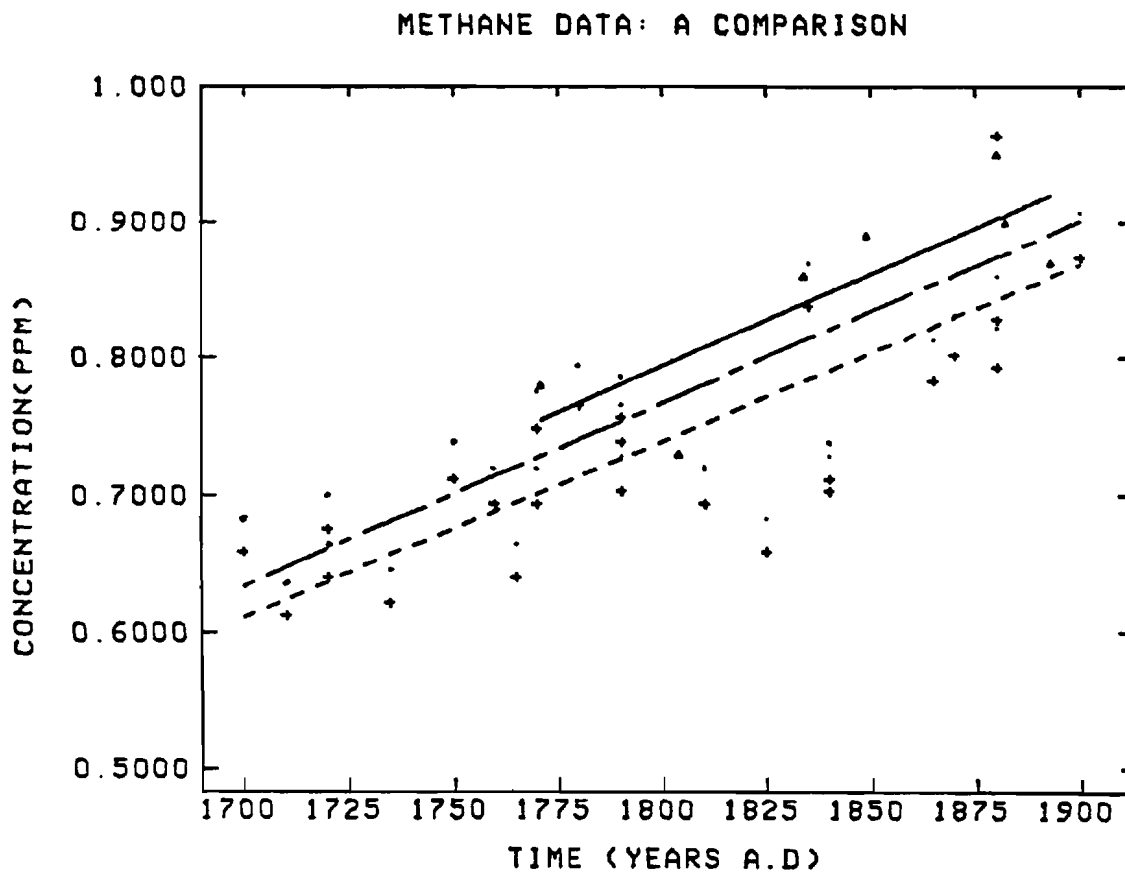
**Figure 4.D.1** Figure shows a plot of all polar icecore  $CH_4$  measurements. The logarithmic time scale, in terms of number of years before present (BP), spans a period of nearly 4000 years.



**Figure 4.D.2** Figure shows polar icecore  $CH_4$  measurements in the last 1000 years, an expanded view of Figure 4.D.1. A nonlinear regression brings out the recent increase in methane levels.



**Figure 4.D.3** Figure shows the relative rate of change of atmospheric CH<sub>4</sub> levels. The details of the calculations are presented in section 4.D. The vertical bars in the plot indicate 90% confidence limits.



**Figure 4.D.4** Figure shows a comparison of Rasmussen and Khalil's (1984) polar icecore  $CH_4$  measurements with Stauffer et al's (1985) data. Rasmussen's data have been corrected for N/S interhemispheric ratios of 1.07 and 1.11.

Key:

\_\_\_\_\_ and  $\blacktriangle$  Stauffer et al.'s data

----- and  $\bullet$  Rasmussen's (N/S = 1.11)

-.-.- and  $+$  Rasmussen's (N/S = 1.07)



**Table 4.B.1**  
**CH<sub>4</sub> Concentrations in Polar Icecores**

| Depth<br>(meters) | Age of Air<br>(Year) | Methane<br>(ppmv) | Site                   | Reference                  |
|-------------------|----------------------|-------------------|------------------------|----------------------------|
| 81.88             | 1954                 | 1.31              | Greenland<br>(65°N)    | Craig&Chou<br>(1982)       |
| 82.30             | 1954                 | 1.21              |                        |                            |
| 101.23            | 1916                 | 1.09              |                        |                            |
| 150.65            | 1837                 | 0.98              |                        |                            |
| 225.69            | 1662                 | 0.80              |                        |                            |
| 898.36            | 270BC                | 0.65              |                        |                            |
| 1203.23           | 1570BC               | 0.71              |                        |                            |
| 1768.58           | 7880BC               | 0.76              |                        |                            |
| 1950.70           | 25220BC              | 0.65              |                        |                            |
| 97.82             | 1790                 | 0.84              | Crete<br>(71°N)        | Rasmussen&Khalil<br>(1984) |
| 119.335           | 1720                 | 0.71              |                        |                            |
| 139.704           | 1650                 | 0.64              |                        |                            |
| 149.908           | 1620                 | 0.67              |                        |                            |
| 169.127           | 1560                 | 0.65              |                        |                            |
| 190.415           | 1470                 | 0.63              |                        |                            |
| 83.95             | 1880                 | 1.07              | Camp Century<br>(77°N) |                            |
| 89.81             | 1870                 | 0.89              |                        |                            |

| Depth<br>(meters) | Age of Air<br>(Year) | Methane<br>(ppmv) | Site | Reference |
|-------------------|----------------------|-------------------|------|-----------|
| 97.96             | 1840                 | 0.79              |      |           |
| 101.0             | 1825                 | 0.73              |      |           |
| 118.57            | 1780                 | 0.85              |      |           |
| 123.02            | 1770                 | 0.83              |      |           |
| 129.72            | 1760                 | 0.77              |      |           |
| 144.74            | 1710                 | 0.68              |      |           |
| 76.14             | 1900                 | 1.13              |      |           |
| 83.54             | 1880                 | 0.88              |      |           |
| 92.22             | 1865                 | 0.87              |      |           |
| 100.49            | 1840                 | 0.78              |      |           |
| 117.36            | 1790                 | 0.82              |      |           |
| 125.24            | 1770                 | 0.77              |      |           |
| 131.56            | 1750                 | 0.79              |      |           |
| 141.34            | 1720                 | 0.75              |      |           |
| 149.25            | 1695                 | 0.74              |      |           |
| 78.0              | 1900                 | 0.97              |      |           |
| 86.65             | 1880                 | 0.92              |      |           |
| 98.14             | 1835                 | 0.93              |      |           |
| 107.06            | 1810                 | 0.77              |      |           |
| 117.04            | 1790                 | 0.78              |      |           |
| 128.52            | 1765                 | 0.71              |      |           |
| 138.2             | 1735                 | 0.69              |      |           |

| Depth<br>(meters) | Age of Air<br>(Year) | Methane<br>(ppmv) | Site                   | Reference |
|-------------------|----------------------|-------------------|------------------------|-----------|
| 147.32            | 1700                 | 0.73              |                        |           |
| 157.5             | 1660                 | 0.75              |                        |           |
| 168.14            | 1620                 | 0.72              |                        |           |
| 176.9             | 1570                 | 0.75              |                        |           |
| 187.29            | 1520                 | 0.72              |                        |           |
| 197.97            | 1470                 | 0.73              |                        |           |
| 217.81            | 1400                 | 0.76              |                        |           |
| 226.95            | 1370                 | 0.89              |                        |           |
| 248.3             | 1290                 | 0.92              |                        |           |
| 287.35            | 1050                 | 0.68              |                        |           |
| 297.58            | 1110                 | 0.77              |                        |           |
| 89.84             | 1560                 | 0.60              | Byrd Station<br>(80°S) |           |
| 200.68            | 690                  | 0.62              |                        |           |
| 400.24            | 1070BC               | 0.59              |                        |           |
| 109.84            | 1410                 | 0.80              |                        |           |
| 130.75            | 1230                 | 0.67              |                        |           |
| 159.31            | 970                  | 0.69              |                        |           |
| 170.84            | 890                  | 0.65              |                        |           |
| 186.24            | 790                  | 0.65              |                        |           |
| 189.20            | 770                  | 0.63              |                        |           |
| 221.80            | 520                  | 0.64              |                        |           |

| Depth<br>(meters) | Age of Air<br>(Year) | Methane<br>(ppmv) | Site | Reference |
|-------------------|----------------------|-------------------|------|-----------|
| 260.87            | 190                  | 0.62              |      |           |
| 319.14            | 310BC                | 0.57              |      |           |
| 370.46            | 830BC                | 0.63              |      |           |
| 381.96            | 930BC                | 0.52              |      |           |
| 175.73            | 860                  | 0.69              |      |           |
| 186.49            | 790                  | 0.62              |      |           |
| 195.55            | 730                  | 0.65              |      |           |
| 201.1             | 690                  | 0.68              |      |           |
| 221.05            | 530                  | 0.60              |      |           |
| 231.04            | 440                  | 0.66              |      |           |
| 241.47            | 350                  | 0.64              |      |           |
| 252.23            | 250                  | 0.64              |      |           |
| 261.23            | 190                  | 0.64              |      |           |
| 271.18            | 110                  | 0.63              |      |           |
| 281.13            | 020                  | 0.65              |      |           |
| 114.79            | 1370                 | 0.68              |      |           |
| 97.61             | 1510                 | 0.66              |      |           |
| 121.01            | 1280                 | 0.69              |      |           |
| 105.3             | 1440                 | 0.69              |      |           |
| 135.39            | 1200                 | 0.63              |      |           |
| 166.47            | 920                  | 0.69              |      |           |

| Depth<br>(meters) | Age of Air<br>(Year) | Methane<br>(ppmv) | Site                    | Reference                 |
|-------------------|----------------------|-------------------|-------------------------|---------------------------|
| 76.52             | 1650                 | 0.65              |                         |                           |
| 90.55             | 1560                 | 0.70              |                         |                           |
| 105.79            | 1440                 | 0.66              |                         |                           |
| 119.82            | 1340                 | 0.64              |                         |                           |
| 141.37            | 1140                 | 0.70              |                         |                           |
| 159.54            | 960                  | 0.70              |                         |                           |
| 173.84            | 870                  | 0.70              |                         |                           |
| 190.85            | 760                  | 0.80              |                         |                           |
| 204.57            | 660                  | 0.67              |                         |                           |
| 223.70            | 420                  | 0.68              |                         |                           |
| 265.21            | 150                  | 0.82              |                         |                           |
|                   | 1850                 | 0.47              | Camp Century<br>(77°N)  | Robbins et al.<br>(1973)  |
|                   | 1815                 | 0.60              |                         |                           |
|                   | 1780                 | 0.69              |                         |                           |
|                   | 1300                 | 0.56              | Byrd Station<br>(80°S)  |                           |
|                   | 800                  | 0.58              |                         |                           |
|                   | 500BC<br>BC          | 0.58              |                         |                           |
| 78.6              | 1955                 | 1.30              | Siple Station<br>(76°S) | Stauffer et al.<br>(1985) |
| 82.6              | 1950                 | 1.18              |                         |                           |
| 88.0              | 1940                 | 1.11              |                         |                           |

| Depth<br>(meters) | Age of Air<br>(Year) | Methane<br>(ppmv) | Site                 | Reference |
|-------------------|----------------------|-------------------|----------------------|-----------|
| 96.4              | 1925                 | 1.02              |                      |           |
| 100.0             | 1919                 | 1.00              |                      |           |
| 113.0             | 1893                 | 0.87              |                      |           |
| 119.0             | 1882                 | 0.90              |                      |           |
| 130               | 1861                 | 0.83              |                      |           |
| 136.0             | 1849                 | 0.89              |                      |           |
| 144.0             | 1834                 | 0.86              |                      |           |
| 160.0             | 1804                 | 0.73              |                      |           |
| 177.0             | 1771                 | 0.78              |                      |           |
| 78.0              | 1956                 | 1.34              |                      |           |
| 80.0              | 1954                 | 1.26              |                      |           |
| 83.0              | 1949                 | 1.16              |                      |           |
| 96.0              | 1927                 | 1.10              |                      |           |
| 101.0             | 1917                 | 0.99              |                      |           |
| 107.0             | 1907                 | 0.99              |                      |           |
| 120.0             | 1880                 | 0.95              |                      |           |
| 132.0             | 1857                 | 0.90              |                      |           |
| 147.0             | 1827                 | 0.83              |                      |           |
| 160.0             | 1804                 | 0.84              |                      |           |
| 177.0             | 1771                 | 0.80              |                      |           |
| 153.0             | 1630                 | 0.84              | South Pole<br>(90°S) |           |

| Depth<br>(meters) | Age of Air<br>(Year) | Methane<br>(ppmv) | Site | Reference |
|-------------------|----------------------|-------------------|------|-----------|
| 154.0             | 1624                 | 0.84              |      |           |
| 215.0             | 1                    | 0.73              |      |           |
| 216.0             | 1                    | 0.66              |      |           |

**Table 4.D.1**  
**Relative Rate of Increase of  $CH_4$**

| Year | $\bar{C}$<br>(ppmv) | $\beta$<br>(%/yr) | 90% confidence<br>limits of $\beta$<br>(%/yr) |
|------|---------------------|-------------------|---|
| 1525 | 0.6825              | -0.0015           | +0.0064 -0.0045                               |
| 1575 | 0.6808              | +0.0050           | +0.0027 +0.0094                               |
| 1625 | 0.6983              | +0.095            | +0.076 +0.118                                 |
| 1675 | 0.7161              | +0.006            | -0.013 +0.041                                 |
| 1725 | 0.7421              | +0.1334           | +0.125 +0.142                                 |
| 1775 | 0.7888              | +0.1103           | +0.107 +0.113                                 |
| 1825 | 0.8397              | +0.1391           | +0.124 +0.154                                 |
| 1875 | 0.9276              | +0.2531           | +0.251 +0.254                                 |



## 5. IR Spectroscopic and Russian Methane Data

### 5.A Introduction:

Infrared spectroscopy (IR) was the first laboratory technique available to several scientists studying trace gases of the atmosphere. In 1948, Marcel Migeotte used this technique to identify atmospheric methane. The method gained wider applications since then and almost all of the early methane measurements were made using this procedure until the recognition of gas chromatographic tools. In first section of this chapter, a presentation of all available IR data has been made. The next section concentrates on a critical review, the possible uncertainties associated with the method and the theoretical procedures, and a trend analysis from the limited information. The chapter concludes with a section on Russian IR, He-Ne laser data and a critical review of their measurements.

### 5.B IR Measurements:

The existence of atmospheric methane was demonstrated spectroscopically by Migeotte (1948 a, b). Migeotte observed fourteen regularly spaced and intense lines when mapping the solar spectrum in the  $3.3\mu$  region. By comparison with Nielsen's laboratory measurements of the  $3.3\mu$  fundamental band of  $CH_4$ , Migeotte concluded that the solar absorption as caused by the P branch of the  $\nu_3$  band of  $CH_4$ . The author indicates that there was no interference of water vapor in this region from the spectral data obtained by H. H. Nielsen. Migeotte (1948c) also

identified the lines in the  $7.7\mu$  region, observed by Adel over Flagstaff, Arizona to be due to methane absorption. Adel (1949) reported the agreement and the confirmation of the presence of atmospheric methane from his 1940 solar spectrum data.

McMath et al. (1948a) identified a band system centered at  $1.66\mu$  as due to absorption by atmospheric  $CH_4$  molecules. The spectrum was registered in the form of direct intensity tracings by a Speedomax recorder at the McMath-Hulbert Observatory, Lake Angelus, Michigan. The authors found that the wave numbers of the band components of their solar observations to be systematically lower than that of laboratory measurements, which they attributed to the higher resolution of the spectrometer. The authors, in their subsequent paper (McMath et al., 1948b), analyzed equivalent widths of P and R branches of the  $2\nu_3$  band at  $1.66\mu$  region for the abundance of methane. By comparing the atmospheric methane intensities with those produced in the laboratory (incandescent lamp source with an absorption cell containing known quantity of methane at 25 cm pressure and atmospheric temperature), the authors determined mass abundance of methane to be 1.18 ppm. The result, presented in Table 5.D.1, is based on an average tropospheric height of 8km. The details of the computations and the theoretical assumptions are presented in the paper by the authors (McMath et al., 1949). Gluekauf (1951) postulated that the methane content computed by McMath et al. may be 1.2 ppm by volume instead of about 2.2 ppmv (or 1.18 ppm by mass). Gluekauf's hypothesis, based on  $CH_4$  amount in Kr and Xe fraction obtained during air distillation process, does not offer any conclusive evidence for the discrepancy since additional results confirming the hypothesis are not

available.

Goldberg (1951) studied the mass abundance of methane based on theoretical formulations and IR measurements. Observations were made at Lake Angelus, Michigan (elevation: 296 meters) and Mount Wilson (elevation: 1742 meters) starting with May, 1949. The intensities of 0-1, 5-6, and 10-11 lines of the positive branch of the  $2\nu_3$  band of  $CH_4$ , observed in the solar spectrum, were analyzed and used in the theoretical method to compute the abundance of methane. The reported mass abundance of  $CH_4$  in terms of number of molecules per square centimeter, is presented in Table 5.B.1. Goldberg and Müller (1953), in a further investigation, applied low sun method which showed that methane was confined to about the first 15km of the atmosphere.

Nielsen and Migeotte (1952) extended Goldberg's procedure to study the methane concentrations over Jungfrauoch, Switzerland (elevation: 3580 meters). The 0-1, 5-6, and 10-11 spectral lines in  $2\nu_3$  band of methane were observed during October, 1951. The abundance of  $CH_4$  reported by the authors is given in Table 5.B.1. The authors show that their observation is consistent with Goldberg's conclusion that methane decreases exponentially with the main body of the atmosphere.

Bowman and Shaw (1963) measured nitrous oxide, carbon monoxide, and methane by IR analysis of ground level air. Methane abundance reported by the authors was determined by measuring the integrated absorption of the P branch of  $3.3\mu$   $CH_4$  band. The datum is included in Table 5.B.1.

Fink et al. (1964) obtained IR line profiles of  $CH_4$  absorption spectrum at the

Pennsylvania State University. The total integrated intensities were determined from R(0) and P(2) lines of the  $2\nu_3$  band. The average abundance reported by the authors is included in Table 5.B.1. The authors also report calibration experiments; a review of earlier measurements and indicate a possible  $\pm 15\%$  uncertainty in their data.

Rinsland et al.(1985) reanalyzed solar absorption spectra recorded at Jungfraujoch in April, 1951 and compared the results with Kitt Peak solar spectra recorded in February, 1981. The authors deduced a mean tropospheric  $CH_4$  mixing ratio of  $1.14 \pm 0.08$  ppmv and  $1.58 \pm 0.09$  ppmv from these two analyses respectively. The authors indicate possible uncertainties associated with IR technique which will be detailed in next section. The above mentioned data has been included in Table 5.B.1.

### 5.C Review and Trend Analysis:

The earlier IR observations (Migeotte 1948 a,b,c; McMath 1948a) were mainly concentrated towards establishing the presence of methane in the atmosphere. The IR procedure, unlike the GC technique, does not measure the concentration of methane directly. Goldberg (1951) employed theoretical expressions to compute methane burden in the atmosphere from IR data. Fink et al. (1964) pointed out that previous investigators (Goldberg, 1951; Nielsen and Migeotte, 1952) obtained lower effective temperature of the atmosphere, 206K and 225K respectively, which has significant effect on computed values of integrated absorption. The integrated absorption  $A$  of a spectral line per unit path per unit stan-

standard pressure is given by: (Fink et al, 1964; see also references therein)

$$A = \frac{1}{pL} \int \ln\left(\frac{I_0}{I}\right) d\nu$$

If  $A_l$  is the value measured in the laboratory at some temperature  $T_l$  then value of  $A_s$  at some desired temperature  $T_s$  can be obtained from:

$$\frac{A_l}{A_s} = \left(\frac{T_s}{T_l}\right)^3 \exp\left(\frac{E_J}{k} \left(\frac{1}{T_s} - \frac{1}{T_l}\right)\right)$$

The calculations of  $A_s$  in the temperature range of 200K to 250K show that the integrated absorptance ( $A_s$ ) may be overpredicted by upto 33% when  $T_s = 200$ K. Consequently,  $CH_4$  abundance (in atm.cm units) estimated by Goldberg; Nielsen and Migeotte may be higher than the actual values. Table 5.C.1 gives a gist of the error analysis.

Rinsland et al.(1985) report several instrumental factors that contribute to the uncertainties in IR data. They also report an empirical correction factor of 1.4 which when applied to Goldberg's, and Nielsen and Migeotte's data (not to Fink et al., measurements) yield  $CH_4$  concentrations that are consistent with their calculations. It is clear, from temperature ( $T_s$ ) uncertainty analysis in Table 5.C.1, that the correction factor is infact a temperature correction that has to be applied to the data since lower atmospheric temperatures were obtained by Goldberg (1951), and Nielsen and Migeotte (1952).

Much of the atmospheric methane is confined within the troposphere ( $H \approx 12$ km). Any methane abundance computation from IR data depends on the height of the vertical column of air above the location of observations. Consequently, the elevation of the site has to be considered in each case and this fact

has been demonstrated sufficiently by Goldberg (1951) , and Nielsen and Migeotte (1952). Based on total number of air molecules in the atmosphere (Khalil, 1979) the methane concentration in ppmv can be computed for any site of known elevation from:

$$C = A \frac{n_m}{N_\infty}$$

where  $n_m$  is total number of methane molecules/cm<sup>2</sup>;  $N_\infty$  is the total number air molecules above the site and A is the total area of earth at the elevation in square centimeters. The converted values of CH<sub>4</sub> concentration from IR data are also presented in Table 5.B.1.

A trend analysis study of IR data is not feasible with such short and scattered database as reported in the previous section. However, consistent methane concentration calculations for two distinct years, as has been carried out by Rinsland et al. (1985), indicate that methane rise during the period 1951-81 may be of the order of 1% per year. This result is in good agreement with the increase computed from GC measurements that form a part of the results of the previous sections.

#### 5.D Russian Methane Data:

A large number of atmospheric methane measurements using the IR technique, and He-Ne laser system have been reported by the Russian scientists starting in the mid 70s. Many of the reported measurements may not be representative of background levels for reasons that follow. However, the available Russian literature is reviewed and background values have been tabulated for

completeness.

Ivanov-Klokov et al. (1975) reported IR measurements of methane made at the Zvenigorod Scientific Station (ZSS) made during 1972-74 and at several field sites in Russia. The authors report that all their measurements, except the R(0) line of  $2\nu_3$  band in 1973, are in agreement within  $\pm 10\%$ . An average methane intensity for 1972-74 of 1.0 atm.cm extracted from authors' paper (see figure 3) is included in Table 5.D.1. The authors also indicate possible direct natural gas contamination in their anomalous samples.

Lukshin et al. (1977) measured methane concentrations at ZSS using He-Ne laser apparatus during the period December, 1975 - February, 1976. The reported  $CH_4$  concentrations are in the range of 1.0-2.5 ppmv. The authors report that the average volumetric concentration during the observation period varied by a factor of two without any anomaly. The authors also report that simultaneous GC measurements made during the same period agree only within 50%. A look at the authors' graphical data (figures 2 and 3 in paper) show that the higher concentrations are in the last ten days of their sampling period of three months. The values presented in Table 5.D.1 represent the monthly averages in first two months of the measurements.

Dianov-Klokov et al. (1977) reported several sets of aircraft flight methane measurements using He-Ne laser technique. A summary of their reported observations is as follows: (1) The methane concentration varied from 1 to 5 ppmv over various stations in flights at an altitude of 100m; but many of the measurements are clustered around a mean of 2.5 to 3.0 ppmv. (2) Many of the high methane

concentrations were observed over developing oil and natural gas fields. (3) Some of the anomalies were stable while others were not; also some of the anomalous measurements were over stations not associated with oil/natural gas deposits. (4) Estimates of  $CH_4$  lifetimes, on the basis of these profiles, were in the range of 0.12 to 20 years. The above listed points neither explain the anomaly in the authors' measurements nor help distinguish the background levels from the rest of data. Also the stability of He-Ne laser system was not reported. Hence these observations have been excluded from Table 5.D.1.

Lukshin et al. (1978) studied methane flux from aircraft flight data gathered during April, 1975 over Vitebsk region. The methane concentration falls off rapidly from about 2 ppmv to about 1 ppmv in the 0-5 km layer of the atmosphere. Such a sharply decreasing vertical profile has not been observed in any of the GC studies and may have been due to strong local sources. Also Dianov-Klokov et al. (1977) observed anomalous readings over this region. For the above reasons, these measurements are not included in Table 5.D.1.

Lukshin and Sklyarenko (1979a) obtained methane flux from ZSS methane data of the period 1974-76. The  $CH_4$  concentrations were observed to be in the range of 1.0-3.5 ppmv which may have been due to reasons detailed earlier. However average methane intensities (cm.atm units) are in agreement with that of other workers and have been included in Table 5.D.1. Lukshin and Sklyarenko (1979b), in a similar study over regions of petroleum and gas extractions, found high levels of methane.

Yurganov et al. (1979) observed  $CO$ ,  $CH_4$ , and  $N_2O$  in atmosphere over both



the hemispheres aboard ship cruises along the routes Odessa-Antarctica and Antarctica-Leningrad during November- December, 1977 and May-June, 1978 respectively. The spectral resolution of IR apparatus was  $0.3 \text{ cm}^{-1}$  near  $3.3\mu \text{ CH}_4$  band. The accuracy of average daily methane abundance values, based on 10-12 spectrograms, was  $\pm 12-15\%$ . The authors report that their latitudinal methane measurements exceed that of Wilkniss et al. (1973) by about 22% and the reasons for this discrepancy are not known. The volumetric methane concentration record digitized from figure 4 of authors' paper is given in Table 5.D.1.

Malkov et al. (1980) report methane concentrations measured at Molodezhnaya Antarctic Station ( $68^\circ\text{S}$ ) during January-April, 1978 using He-Ne laser system. The authors indicate an average error of 0.13ppmv in their measurements that may be due to equipment and methodological errors. The reported average  $\text{CH}_4$  concentration of 1.32 ppmv is in agreement with the observations reported by others (Swinnerton et al., 1969; Larson et al., 1972; Ehhalt, 1978b). The average value is included in Table 5.D.1.

Bogdanov et al. (1980) measured methane in the atmosphere at Cape Kaliakara Station ( $43^\circ\text{N}$ ) in Bulgaria during July-August, 1978. The authors report that their measurements agree well with ship cruise measurements of 1978 (Yurganov et al., 1979). The monthly average methane intensities calculated from daily average values are given in Table 5.D.1.

The  $\text{CH}_4$  measurements made by Russian scientists are not sufficiently spread in time to apply trend analysis. The lower precision of many of the observations and the large variability in data also discourage short-term trend studies.

It is to be noted that much of the Russian work is focused on flux studies which do not warrant measurements spread over seasons or long databases. Particularly observations over oil and natural gas fields do not represent background methane levels and can not be considered for analyses that require clean air data. It is well established that high  $CH_4$  concentrations can be expected near petroleum drilling and production operations (Brooks and Sackett, 1973).

**Table 5.B.1**  
**IR Measurements of Methane**

| Month    | Year | Measurement<br>(atm.cm) | Station                     | Concentration<br>(ppmv) | Reference                  |
|----------|------|-------------------------|-----------------------------|-------------------------|----------------------------|
| March    | 1948 | 1.18                    | Lake Angelus,<br>Michigan   | 2.170                   | McMath et al.<br>(1948b)   |
| April    | 1950 | $3.2 \cdot 10^{10}^b$   | Lake Angelus,<br>Michigan   | 1.582                   | Goldberg(1951)             |
| June     | 1950 | $2.6 \cdot 10^{10}^b$   | Mount Wilson                | 1.518                   | "                          |
| October  | 1951 | $2.09 \cdot 10^{10}^b$  | Jungfrauoch,<br>Switzerland | 1.581                   | Nielsen&Migeotte<br>(1952) |
| -        | 1962 | 1.40                    | Columbus, Ohio              | 1.700                   | Bowman&Shaw<br>(1963)      |
| -        | 1963 | 1.11                    | Penn. State<br>University   | -                       | Fink et al. (1964)         |
| February | 1981 | -                       | Kitt Peak                   | 1.580                   | Rinsland et al<br>(1985)   |
| April    | 1951 | -                       | Jungfrauoch,<br>Switzerland | 1.140                   | "                          |

b - computed abundance in molecules per  $cm^2$

**Table 5.C.1**  
**Error Analysis of Integrated Absorption ( $A_s$ )**

| $T_s$<br>(K) | $\frac{A_l}{A_s}$ | $A_s$<br>( $\times A_l$ ) | % error in $A_s$ |
|--------------|-------------------|---------------------------|------------------|
| 250          | 0.795             | 1.258                     | 0.00             |
| 240          | 0.754             | 1.326                     | 5.40             |
| 230          | 0.714             | 1.399                     | 11.21            |
| 225          | 0.695             | 1.439                     | 14.39            |
| 220          | 0.675             | 1.481                     | 17.72            |
| 215          | 0.656             | 1.524                     | 21.17            |
| 210          | 0.637             | 1.569                     | 24.72            |
| 205          | 0.618             | 1.618                     | 28.61            |
| 200          | 0.599             | 1.669                     | 32.67            |

$$T_l = 298\text{K}$$

**Table 5.D.1**  
**Russian IR/Laser Measurements of Methane**

| Month    | Year    | Concentration<br>(ppmv) | Station    | Reference                     |
|----------|---------|-------------------------|------------|-------------------------------|
| -        | 1972-74 | 1.00'                   | Zvenigorod | Ivanov-Klokov<br>et al.(1975) |
| December | 1975    | 1.42                    | Zvenigorod | Lukshin et al<br>(1977)       |
| January  | 1976    | 1.30                    |            |                               |
| -        | 1975    | 1.36'                   | Zvenigorod | Lukshin&Sklyarenko<br>(1979a) |
| -        | 1976    | 1.46'                   |            |                               |
| November | 1977    | 1.50                    | 46°N       | Yurganov et al.<br>(1979)     |
| "        | "       | 1.76                    | 36°N       |                               |
| "        | "       | 1.56                    | 30°N       |                               |
| "        | "       | 1.64                    | 26°N       |                               |
| "        | "       | 1.90                    | 21°N       |                               |
| "        | "       | 1.80                    | 17°N       |                               |
| "        | "       | 2.08                    | 02°N       |                               |
| "        | "       | 2.10                    | 19°S       |                               |
| "        | "       | 1.77                    | 20°S       |                               |
| "        | "       | 1.68                    | 30°S       |                               |
| May      | 1978    | 1.72                    | 58°N       |                               |

| Month  | Year | Concentration<br>(ppmv) | Station                  | Reference                 |
|--------|------|-------------------------|--------------------------|---------------------------|
| "      | "    | 1.58                    | 56°N                     |                           |
| "      | "    | 1.74                    | 50°N                     |                           |
| "      | "    | 1.50                    | 22°N                     |                           |
| "      | "    | 1.56                    | 19°N                     |                           |
| "      | "    | 1.81                    | 05°S                     |                           |
| "      | "    | 1.73                    | 07°S                     |                           |
| "      | "    | 1.97                    | 13°S                     |                           |
| "      | "    | 1.73                    | 23°S                     |                           |
| March  | 1978 | 1.32                    | Molodezhnaya<br>(68°S)   | Malkov et al.<br>(1980)   |
| July   | 1978 | 1.50*                   | Cape Kaliakara<br>(43°N) | Bogdanov et al.<br>(1980) |
| August | 1978 | 1.50*                   |                          |                           |

\* Methane intensity in atm.cm units

## 6. Theoretical Studies

### 6.A Introduction:

Atmospheric methane is shown, beyond doubt, to be increasing at a steady rate from the data and analyses presented in the previous chapters. A review of some of the literature dealing with theoretical studies of cause and effect relations of increasing  $CH_4$ , and an inventory of methane sources is complimentary at this stage. Methane rise can occur only under two circumstances; either when global methane production and release is increasing or when global sinks of methane are disappearing or a combination of these two basic processes. Another aspect of importance is the possible effects in an increasing atmospheric methane. The chapter begins with a section on global  $CH_4$  source budget. The possible effects of increasing atmospheric methane, namely greenhouse effect, depletion of hydroxyl radicals, effects on stratospheric ozone, and effects on tropospheric and stratospheric chemistry which influence the global atmosphere will be discussed next.

### 6.B Sources of Atmospheric Methane:

The Global Tropospheric Chemistry Panel of the National Research Council in their recent report ( 1984 ), presented detailed background information on most of the tropospheric trace gas species. The significant sources were catalogued in the report of which tropic-dry, rice-agriculture, temperate grasslands, and wetlands were classified as major sources with strong evidence.

In a study of the atmospheric cycle of methane, Ehhalt (1974) listed both natural and anthropogenic sources of this trace gas. The author found that enteric fermentation of animals, paddy fields, and swamps and marshes to be of dominant nature in the production and release of biogenic methane into the atmosphere. With an anthropogenic component of  $\approx 210$  Tg/year ( 1 Tg =  $10^{12}$ grams ), Ehhalt estimated a global annual production of 545 to 1035 Tg of  $CH_4$  and computed a global burden of 4000 Tg from a methane lifetime of 4-7 years. Ehhalt and Schmidt (1978) reviewed and revised the global methane budget estimate which was not significantly different from the earlier one presented by Ehhalt (1974). The revised estimate is presented in Table 6.B.1.

Harriss and Sebacher (1981) carried out a study to estimate the methane flux from freshwater swamps. The authors measured methane emissions at several swamps in southeastern United States with a gas-filter-correlation (GFC) non-dispersive infrared absorption analyzer integrated with a flowing  $0.5m^3$  chamber. Harriss and Sebacher observed high methane flux from swamps that had a supply of organic matter ( treated sewage ) and that the flux was directly proportional to the organic content of the soil, and the thickness of soil layer containing such organic matter. The authors, from their detailed measurements, concluded that there might be a very high level of uncertainty associated with previous flux estimates from swamps ( Ehhalt, 1974; Ehhalt and Schmidt, 1978 ). Harriss et al. (1982) conducted a similar methane flux study at Great Dismal Swamp (GDS), Virginia. GFC technique ( Harriss and Sebacher, 1981) was used to make the measurements. The authors found that GDS soil can act both as a source and a sink for atmospheric methane. This finding is a departure from the normal belief that



swamps are a strong source of methane and illustrates the complexity of the processes associated with methane release mechanism.

Bartlett et al. ( 1985 ) examined the seasonal methane flux from saltmarsh soils in three different vegetation zones at Bay Tree Creek near Yorktown, Virginia. The authors used GFC method for their measurements and estimated annual mean methane fluxes of 0.43, 1.30, and 1.20  $g/cm^2$  from Salt meadow, short *S. alterniflora*, and tall *S. alterniflora* respectively. The fluxes, computed from a total of 100 measurements made over a period of two years, exhibited summer and fall maximums. The important findings of the study were (i) High spatial and temporal variability of  $CH_4$  fluxes (  $-2.4$  to  $21.3 \times 10^{-8} g/m^2 day$  ), and (ii) Salt marshes make only a minor contribution to global methane source budget. Cicerone and Shetter (1981) also observed low  $CH_4$  flux from saltwater marshes. Ehhalt and Schmidt (1978) estimate of 190-300 Tg/year methane flux from swamps and marshes may be too high compared with Bartlett et al. (1985) figure of about 0.3 Tg/year from salt marshes. However, the area of global salt marshes is about 15% of that of the swamps and marshes put together.

Cicerone and Shetter (1981) made field measurements of methane fluxes from rice paddies, freshwater lakes, and saltwater marshes. The authors used three different gas collection systems to make  $CH_4$  flux observations from open water, plant material and rice paddies respectively. The results of the rice paddy measurements, the first of such field studies, are of relevance in this analyses of methane flux literature. The authors computed methane flux in the same manner in which Koyama (1963) first calculated the  $CH_4$  flux from rice paddy fields in

Japan and found that their estimates (59 Tg/year) were only about 20% of that of Koyama's. Cicerone and Shetter's data show that the  $CH_4$  flux is dependent on the type of fertilizer used and that the quantity of N fertilizer used may also be an important variable. The field study results indicate the possibility of a large uncertainty involved with rice paddy flux estimates and this fact is further accentuated in the assessment of total biogenic methane sources of which about 40% is from rice paddy fields ( Ehhalt, 1974 ).

Khalil and Rasmussen (1983) presented a methane budget on the basis of global  $CH_4$  mass balance, taking into account possible overestimations in the previous budgets. This carefully constructed methane data is presented in Table 6.B.2. It is interesting to note that the authors have provided a margin in their methane budget under source class 'others'. This class takes into account some of the unidentified or less identified sources, for example methane production by termites (Rasmussen and Khalil, 1983). Using four box global model and a  $CH_4$  source strength of 550 Tg/year, Khalil and Rasmussen (1983) estimated  $CH_4$  concentrations that were in agreement with the observations. Logan et al. (1981) calculated a methane budget of 580 Tg/year which is similar to Rasmussen and Khalil's estimate.82) Walker (1977) has estimated the emissions to be 1490 Tg/year. Sheppard et al. (1982) published a high methane budget of 1210 Tg/year. The authors projected about 75% of their  $CH_4$  budget to be of tropical forest origin. Such large sources in the tropical region are bound to show higher methane levels in the tropics which is in contradiction to the observed  $CH_4$  profiles. This indicates a possible error in Sheppard et al.'s estimates. Khalil and Rasmussen (1985d) explored the global trace gas scenario with box models to

explain the different aspects like seasonal variations, lifetime of trace species etc., on a solid scientific basis. Their analyses of methane data and the observed global cycles and distributions confirm total  $CH_4$  source to be about 550 Tg/year.

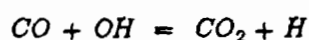
Global methane source budget is subject to large uncertainties. Atmospheric CO-OH- $CH_4$  cycle may also lead to higher methane levels due to increasing CO sources (Sze, 1977; Chameides et al., 1977; Crutzen and Fishman, 1977) indicating larger methane source budget. However, based on observed global distribution data, constraints can be imposed on the  $CH_4$  production to detect and eliminate anomalous information. For example, constant vertical  $CH_4$  profile in troposphere preclude any production of methane by chemical reactions within the troposphere. Each one of the budgets presented in Tables 6.B.1 and 6.B.2 have a methane production component due to man related activities (paddy fields, cattle, direct anthropogenic) that forms  $\approx 40\%$  of total methane budget. Therefore a direct relationship between population rise and methane production can be expected (Khalil and Rasmussen, 1985a). Figure 6.B.2 presents such a comparison.

### **6.C Possible Effects of Increasing Atmospheric $CH_4$ :**

The cycle of sources, transport, transformation, and removal of trace constituents of the atmosphere have effects on important global physical processes. Increased levels methane, being no exclusion to this cycle, contributes to the possible global warming, increasing CO, and reduction of hydroxyl radicals. Figure 6.C.1 captures the scenario of possible effects of increasing atmospheric methane. Many of the results available at present are based on theoretical studies that rely

on simplifying assumptions and the extent of available information. A review of the literature, in turn, must sift the material to bring out the major features. The rest of the material in this section is devoted to the above notion.

Wofsy et al. (1972) used a one dimensional model to study the distribution of atmospheric  $CH_4$ , CO and  $CO_2$ . The oxidation of methane mostly by reaction with hydroxyl radicals provides a large source of atmospheric carbon monoxide. The authors, through their atmospheric and photochemical model, demonstrated this aspect taking into consideration several of the possible reactions. The methane oxidation cycle, considered by the authors, is presented in Figure 6.C.2. Wofsy et al. clarified uncertainties related to CO lifetime and their computation of CO production through methane oxidation is an important aspect in studying the adverse impacts of increasing methane. Wofsy (1976) indicated the possible effect of hydroxyl radical depletion due to reaction with CO as given below:



Ehhalt (1974) also proposed a similar theory but was not able to make any estimate of the loss of hydroxyl radical for paucity of data. Khalil and Rasmussen (1985) applied two complementary approaches to determine depletion of OH radicals. The first method was based on population-methane source correlations and the second one relied on observed global methane increases from polar icecore  $CH_4$  concentration data. Both the methods predict a possible 20% depletion of hydroxyl radicals in the past 100-200 years. Levine et al. (1985) used photochemical calculations and ground based infrared spectroscopic  $CH_4$  measurements of 1950-51 to compute depletion of hydroxyl radicals. The authors report that their

model computations indicate a possible 25% reduction of hydroxyl radicals from the levels that existed in the early 50s. When we consider the fact that atmospheric methane concentration has doubled from its pre-industrial levels (see Chapter 4), it is to be expected that hydroxyl radical concentration may also have depleted during this time.

The thermal structure of the earth's atmosphere is influenced by the presence of trace gases with strong infrared (IR) absorption bands. Wang et al. (1976) studied the greenhouse effects due to many trace gas species by employing a radiative-convective model. Earth emits most its energy, from solar radiation, across the broad IR radiation band of 3-15  $\mu\text{m}$ . The 7-14  $\mu\text{m}$  region, called 'atmospheric window', allows terrestrial radiation to escape directly into space. Methane has a strong IR absorption at 7.7  $\mu\text{m}$  and hence  $\text{CH}_4$  molecules in the atmosphere absorb and reemit the radiation back to the earth affecting the global thermal equilibrium. Wang et al. computed a global warming of 0.4 $^{\circ}\text{K}$  from their model studies when methane level had doubled. The possibility of increased water vapor content of the stratosphere due to methane oxidation may also lead to a similar greenhouse effect (Khalil-GH seminar). Ramanathan et al. (1985) reported that an increase of 0.4 ppmv in methane concentration could lead a global warming of 0.12 $^{\circ}\text{K}$  using a one dimensional climatic-radiative model.

Owens et al. (1982) investigated the possible influence of methane increase on ozone and water vapor. The results from their one dimensional model, based on doubling of  $\text{CH}_4$  levels, indicate a possible increase in tropospheric ozone due to methane photo-oxidation and an increase of stratospheric ozone. The model stu-

dies also indicate a possible rise in stratospheric water vapor content.

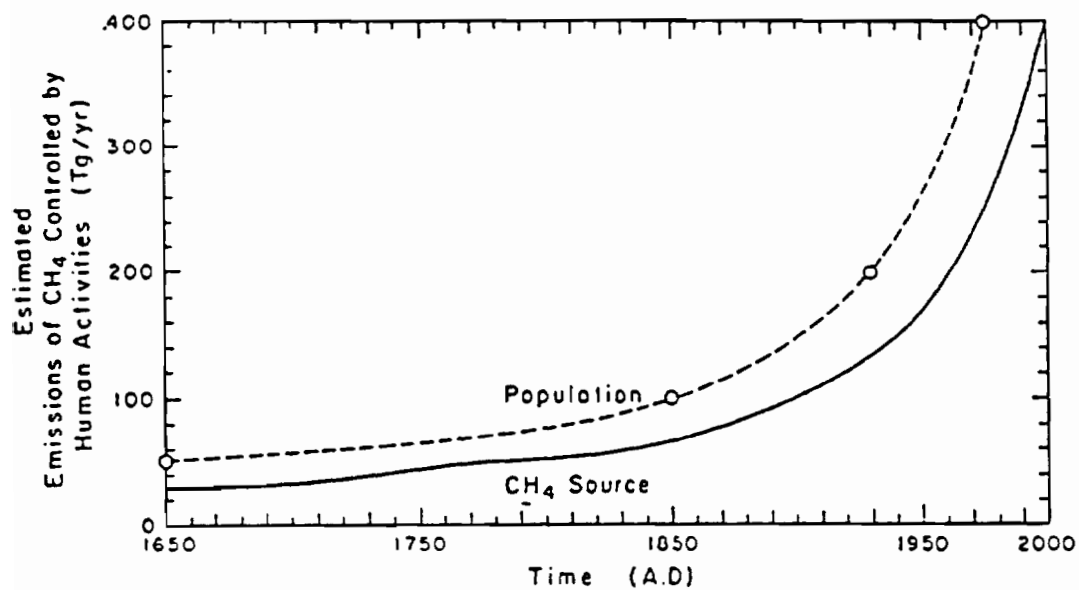
### **6.E Concluding Remarks:**

The global methane emission record is not so well known as the  $CH_4$  concentration information. The uncertainties associated with our current methane production rates and global distribution of sources is rather large to draw any conclusive evidence of a phenomena like methane trend from the emission information alone. The necessity for precise estimates of the global methane sources is obvious. In the absence of such accurate estimations, available information on latitudinal  $CH_4$  distribution etc., can be used as constraints on global methane production. Also the effective use of old methane measurements from polar icecores can facilitate the use of current methane source budget to look for possible trends.

Global studies of trace gases' impact on earth's atmosphere are of importance in understanding the complex behavior of these species and their deleterious effect on our atmosphere, and to impose suitable preventive measures. The possibility of global warming and stratospheric ozone depletion are two of the many such issues that have received wider attention. The clear indication here is a demand for the examination of the trends of trace gases such as  $CH_4$  and to quantify such increases in unambiguous terms.

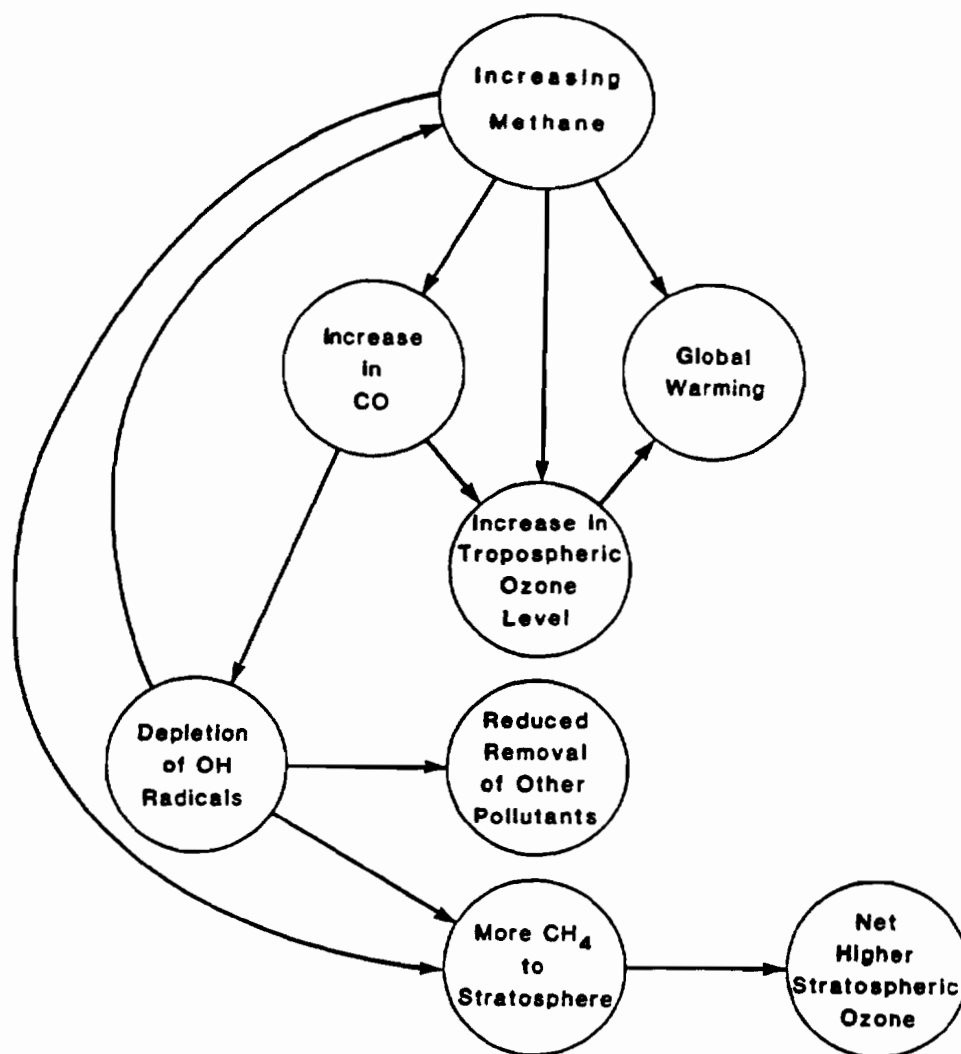
An important aspect that needs more attention at this stage is a global network of stations capable of measuring methane fluxes from different source types as well as atmospheric  $CH_4$  concentrations. The flux measurements are necessary

to establish a global  $CH_4$  emission record. The systematic worldwide measurements of methane are required to study the trend and other aspects of this trace gas. Interlaboratory comparison of standards of different participating groups is essential in any such global effort to study methane. The goal of such a future plan will be the assessment of the impacts of increasing atmospheric methane on the basis of this global database.

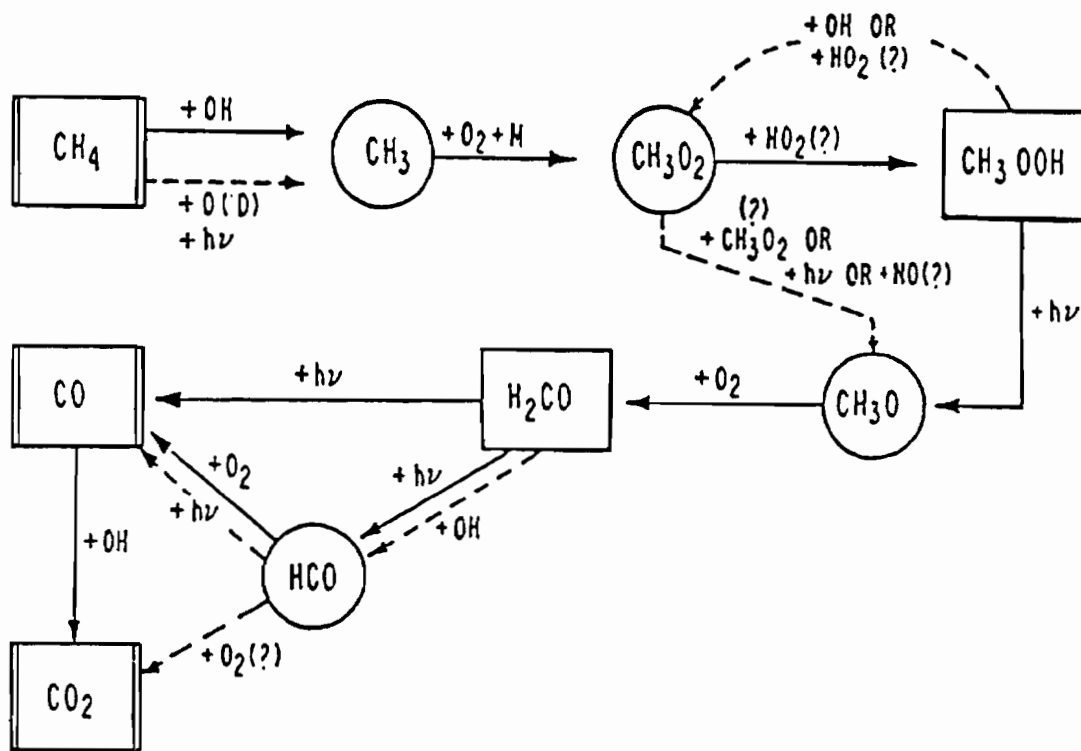


**Figure 6.B.1** Figure shows a plot estimated  $CH_4$  sources in the last 350 years. The world population for the same period is also shown to bring out the possible relation between man-related activities and global methane increase (from Khalil and Rasmussen, 1985a).





**Figure 6.C.1** A block diagram of the possible chain of effects due to increasing atmospheric methane levels. The figure brings out the effects due to methane alone and does not include possible implications of other gases like CO etc.



**Figure 6.C.2** Figure shows  $\text{CH}_4$  oxidation process with most of the prominent reaction chains (from Wofsy et al., 1972).

**Table 6.B.1**  
**Global Sources and Production of  $CH_4$  ( Ehhalt & Schmidt, 1978 )**

| Source  | Annual Production<br>( Tg $CH_4$ /year ) |
|---|--|
| Enteric Fermentation<br>of Animals                          | 100.0 - 200.0                            |
| Paddy Fields  | 280.0                                    |
| Swamps, Marshes   | 190.0 - 300.0                            |
| Fresh water Lakes   | 1.0 - 25.0                               |
| Tundra  | 0.3 - 3.0                                |
| Oceans  | 1.3 - 16.6                               |
| Coal Mining   | 6.3 - 22.0                               |
| Lignite Mining  | 1.6 - 5.7                                |
| Industrial Losses   | 7.0 -21.0                                |
| Automobile Exhaust  | 0.5                                      |
| Volcanic Emissions  | 0.2                                      |
| Total - Biogenic  | 570.0 - 850.0                            |
| Total - Anthropogenic<br>(from $C^{14}$ content of $CH_4$ ) | 140.0 - 210.0                            |

**Table 6.B.2**  
**Global Methane Source Inventory (Khalil and Rasmussen, 1983)**

| Source               | Production<br>( Tg CH <sub>4</sub> /year ) |
|----------------------|--|
| Oceans               | 13.0                                       |
| Wetlands             | 150.0                                      |
| Freshwater lakes     | 10.0                                       |
| Tundra               | 12.0                                       |
| Paddy fields         | 95.0                                       |
| Cattle               | 120.0                                      |
| Biomass burn         | 25.0                                       |
| Direct anthropogenic | 40.0                                       |
| Other                | 88.0                                       |
| Total-All sources    | 553.0                                      |

## 7. General Conclusions

The results of the work presented in chapters 2 through 6 are designed to improve our understanding of the phenomena of rising atmospheric methane concentrations. In addition to collection, interpretation of the  $CH_4$  measurements in a systematic manner is essential in understanding global methane increase.

In the first level, this study concentrated on analyzing 1965-81 methane record, and in locating the period during which methane rise started, in chapters 2 and 4 respectively. The following conclusions are drawn at this level of the investigation:

(i) A global methane trend of about 1% per year can be observed from the analysis of 1965-81 tropospheric GC measurements of methane.

(ii) Trend analysis of polar icecore methane data indicate that the possible increase of atmospheric methane to have begun about 150 years ago.

(iii) Methane mixing ratios found in polar icecores show that the atmospheric levels of this trace gas to have doubled in the last two centuries.

At the next level, systematic measurements of tropospheric methane, IR and Russian methane data, and global sources and possible effects of increasing  $CH_4$  levels have been examined in chapters 3, 5, and 6 respectively. The following is the gist of the details presented in these three chapters:

(i) Continuous and systematic measurements of the period 1979-84 show an increase of 1-1.2% per year in atmospheric levels of methane.

(ii) IR data indicate a possible increase of methane while most of the Russian measurements do not reflect background levels of  $CH_4$  required for a meaningful trend study.

(iii) Theoretical investigations coupled with the global  $CH_4$  observations put the methane source budget at about 550 Tg/year.

(iv) Possibility of a 20-25% depletion of hydroxyl radical concentrations within the last century, and a global warming of 0.2-0.5°K are also attributed increasing methane levels.

## References

- Adel A. "Comparison of Atmospheric Methane Content above Flagstaff, Arizona, and Columbus, Ohio." *Phys. Rev.*, 75, 922-928, 1949
- Altshuller A.P., and Bellar T. *JAPCA*, 19, 3, 1968
- Altshuller A.P., Ortman G.C., Saltzman B.E., and Neligan R.E. "Continuous Monitoring of Methane and Other Hydrocarbons in Urban Atmospheres." Paper presented at the 58th Annual Meeting of Air Pollution Control Association, June 1965
- Bainbridge A.E., Heidt L.E. "Measurement of Methane in the Troposphere and Lower Stratosphere." *Tellus*, XVIII, 221-224, 1966
- Bartlett K.B., Harriss R.C., and Sebacher D.I. "Methane Flux from Coastal Salt Marshes." *J. Geophys. Res.*, 90(D9), 5710-5720, 1985
- Blake D.R., Mayer E.W., Tyler S.C., Makide Y., Montague D.C., and Rowland F.S. "Global Increase in Atmospheric Methane Concentrations between 1978 and 1980." *Geophys. Res. Lett.*, 9(4), 477-480, 1982
- Blake D. R. Ph. D. Dissertation, University of California, Irvine, California, 1984
- Bogdanov S., Videnov P., Dianov-Klokov V.I., and Tarabukhin A. "Spectroscopic Measurements of the Background CO, CH<sub>4</sub>, and N<sub>2</sub>O Contents over Bulgaria." *Izvestiya, Atm. Occ. Phys.*, 16(11), 891-894, 1980
- Bowman R.L., and Shaw J.H. "The Abundance of Nitrous Oxide, Methane, and Carbon Monoxide in Ground-level Air." *App. Opt.*, 2, 176, 1963
- Brooks J.M., and Sackett W.M. "Sources, Sinks, and Concentrations of Light Hydrocarbons in the Gulf of Mexico." *J. Geophys. Res.*, 78(24), 5248-5258, 1973
- Cavanaugh L.A., Schadt C.F., and Robinson E. "Atmospheric Hydrocarbon and Carbon Monoxide Measurements at Point Barrow, Alaska." *Env. Sci. Tech.*, 3(3), 251-257, 1969
- Chameides W.L., Liu S.C., and Cicerone R.J. "Possible Variations in Atmospheric

Methane." *J. Geophys. Res.*, 82(12), 1795-1798, 1977

Cicerone R.J., and Shetter J.D. "Sources of Atmospheric Methane: Measurements in Rice Paddies and a Discussion." *J. Geophys. Res.*, 86(C8), 7209-7209, 1981

Cofer III W.R. "Methane and Nonmethane Hydrocarbon Concentrations in the North and South Atlantic Marine Boundary Layers." *J. Geophys. Res.*, 87(C9), 7201-7205, 1982

Craig H., and Chu C.C. "Methane: The Record in Polar Ice Cores." *Geophys. Res. Lett.*, 9(11), 1221-1224, 1982

Cronn D.R., and Nutmagul W. "Characterization of Trace Gases in 1980 Volcanic Plumes of Mt. St. Helens." *J. Geophys. Res.*, 87(C19), 11159-11160, 1982

Crutzen P.J., and Fishman J. "Average Concentrations of OH in the Troposphere, and the Budgets of  $CH_4$ , CO,  $H_2$ , and  $CH_3CCl_3$ ." *Geophys. Res. Lett.*, 4(8), 921-924, 1977

Dianov-Klokov V.I., Lukshin V.V., Matveyeva O.A., and Sklyarenko I.Ya. "The Distribution of Methane in the Troposphere." *Izvestiya, Atm. Oce. Phys.*, 19(5), 967-972, 1977

Ehhalt D.H. "Methane in the Atmosphere." *JAPCA*, 17(8), 518-519, 1967

Ehhalt D.H., and Heidt L.E. "Vertical Profiles of  $CH_4$  in the Troposphere and Stratosphere." *J. Geophys. Res.*, 78(24), 5265-5271, 1978

Ehhalt D.H. "The Atmospheric Cycle of Methane." *Tellus*, XXVI(1-2), 58-70, 1974

Ehhalt D.H. "The  $CH_4$  Concentration over the Ocean and Its Possible Variation with Latitude." *Tellus*, XXX(2), 169-176, 1978a

Ehhalt D.H., and Schmidt U. "Sources and Sinks of Atmospheric Methane." *Pure Appl. Geophys.*, 116, 459-464, 1978b

Ehhalt D.H., Zander R.J., and Lamontagne R.A. "On the Temporal Increase of Tropospheric  $CH_4$ ." *J. Geophys. Res.*, 88(C19), 8442-8446, 1989

Fabian P., Borchers R., Weiler K.H., Schmidt U., Volz A., Ehhalt D.H., Seiler W., and Muller F. "Simultaneously Measured Vertical Profiles of  $H_2$ ,  $CH_4$ , CO,  $N_2O$ ,  $CFCl_3$ , and  $CF_2Cl_2$  in the Mid-Latitude Stratosphere and Troposphere." *J. Geophys. Res.*, 84(C6), 9149-9154, 1979

Fabian P., Borchers R., Flentje G., Matthews W.A., Seiler W., Giehl H., Bunse K., Muller F., Schmidt U., Volz A., Khedim A., and Johnen F.J. "The Vertical



- Distributions of Stable Trace Gases at Mid-Latitudes." *J. Geophys. Res.*, 86(C6), 5179-5184, 1981
- Fink U., Rank D.H., and Wiggins T.A. "Abundance of Methane in the Earth's Atmosphere." *J. Opt. Soc. Am.*, 54(4), 472-474, 1964
- Fraser P.J., Khalil M.A.K., Rasmussen R.A., and Crawford A.J. "Trends of Atmospheric Methane in the Southern Hemisphere." *Geophys. Res. Lett.*, 8(10), 1069-1066, 1981
- Fraser P.J., Khalil R.A., and Rasmussen R.A. "Tropospheric Methane in the Mid-Latitudes of the Southern Hemisphere." *J. Atmos. Chem.*, 1, 125-135, 1984
- Fraser P.J., Hyson P., Rasmussen R.A., Crawford A.J., and Khalil M.A.K. "Methane, Carbon Monoxide and Methylchloroform in the Southern Hemisphere." *J. Atmos. Chem.*, 1985 (submitted)
- Glueckauf E. "The Composition of Atmosphere." *Compendium of Meteorology, American Meteorological Society*, 9-10, 1951
- Goldberg L. "The Abundance and Vertical Distribution of Methane in the Earth's Atmosphere." *Astrophys. J.*, 113, 567-582, 1951
- Goldberg L., and Muller E.A. "The Vertical Distribution of Nitrous Oxide and Methane in the Earth's Atmosphere." *J. Opt. Soc. Of Am.*, 49(11), 1033-1036, 1959
- Harriss R.C., and Sebacher D.I. "Methane Flux in Forested Freshwater Swamps of the Southeastern United States." *Geophys. Res. Lett.*, 8(9), 1002-1004, 1981
- Harriss R.C., Sebacher D.I., and Day Jr. F.P. "Methane Flux in Great Dismal Swamp." *Nature*, 297, 673-674, 1982
- Heidt L.E., and Ehhalt D.H. "Correction of  $CH_4$  Concentrations Measured Prior to 1974." *Geophys. Res. Lett.*, 7(11), 1023, 1980
- Heidt L.E., Krasnec J.P., Lueb R.A., Pollock W.H., Henry B.E., and Crutzen P.J. "Latitudinal Distribution of CO and  $CH_4$  over the Pacific." *J. Geophys. Res.*, 85(C12), 7929-7936, 1980
- Hemmingsen E. "Permeation of Gases through Ice." *Tellus*, 11, 955-959, 1959
- Hollander M., and Wolfe D.A. *Nonparametric Statistical Methods*, John Wiley, New York, 1978
- Ivanov-Klokov V.I., Lukshin V.V., Sklyarenko I.Ya., and Shakula V. "Variations of Atmospheric Methane Abundance." *Izvestiya, Atm. Oce. Phys.*, 11(10), 623-626,

1975

Khalil M.A.K. Ph. D. Dissertation, Oregon Graduate Center, Beaverton, Oregon, 1979

Khalil M.A.K., and Rasmussen R.A. "Secular Trends of Atmospheric Methane( $CH_4$ )."  
*Chemosphere*, 11(9), 877-889, 1982

Khalil M.A.K., and Rasmussen R.A. "Sources, Sinks, and Seasonal Cycles of Atmospheric Methane."  
*J. Geophys. Res.*, 88(C9), 5191-5144, 1983

Khalil M.A.K. "NSF Chautauqua Short Course on Greenhouse Effect." Oregon Graduate Center, Beaverton, Oregon, 1984

Khalil M.A.K., Rasmussen R.A. "Causes of Increasing Atmospheric Methane: Depletion of Hydroxyl Radicals and the Increase of Emissions."  
*Atmos. Env.*, 19(9), 997-1007, 1985a

Khalil M.A.K., and Rasmussen R.A. "Applications of Trend Analysis Techniques to Atmospheric Trace Gases." Internal Report, Oregon Graduate Center, Beaverton, Oregon, 1985b

Khalil M.A.K., and Rasmussen R.A. "Inter-Annual Variability of Atmospheric Methane: Possible Effects of the El Nino Southern Oscillation Phenomena." *Science*, 1985c (submitted)

Khalil M.A.K., and Rasmussen R.A. "Modeling Chemical Transport and Mass Balances in the Atmosphere." *Environmental Exposure from Chemicals II, Chapter 2*, CRC Press, 1985d

Khalil M.A.K., Rasmussen R.A., and Edgerton S.A. "Gaseous Tracers for Sources of Regional Scale Pollution." *JAPCA*, 35(8), 838-840, 1985

Komhyr W.D., Gammon R.H., Harris T.B., Waterman L.S., Conway T.J., Taylor W.R., and Thoning K.W. "Global Atmospheric  $CO_2$  Distribution and Variations from 1968-1982 NOAA/GMCC  $CO_2$  Flask Sample Data." *J. Geophys. Res.*, 90(D9), 5567-5596, 1985

Koyama T. "Gaseous Metabolism in Lake Sediments Paddy Soils and the Production of Atmospheric Methane and Hydrogen." *J. Geophys. Res.*, 68, 9971-9978, 1969

Lamontagne R.A., Swinnerton J.W., and Linnenbom V.J. "Nonequilibrium of Carbon Monoxide and Methane at the Air-Sea Interface." *J. Geophys. Res.*, 76(21), 5117-5121, 1971

Lamontagne R.A., Swinnerton J.W., Linnenbom V.J., and Smith W.D. "Methane

Concentrations in Various Marine Environments." *J. Geophys. Res.*, 78(24), 5917-5924, 1973

Lamontagne R.A., Swinnerton J.W., and Linnenbom V.J. "C<sub>1</sub>-C<sub>4</sub> Hydrocarbons in the North and South Pacific." *Tellus*, XXIV(1-2), 71-77, 1974

Larson R.E., Lamontagne R.A., and Wilkniss P.E. "Radon-222, CO, CH<sub>4</sub> and Continental Dust over the Greenland and Norwegian Seas." *Nature*, 240, 345-347, 1972

Leifer R., Sommers K., and Guggenheim S.F. "Atmospheric Trace Gas Measurements with a New Clean Air Sampling System." *Geophys. Res. Lett.*, 8(10), 1079-1081, 1981

Levine J.S., Rinsland C.P., and Tennille G.M. "Methane and Carbon Monoxide in the Troposphere- 1950 and 1985: Some Photochemical Considerations." *J. Geophys. Res.*, 1985 (in print)

Logan J.A., Prather M.J., Wofsy S.C., and McElroy M.B. "Tropospheric Chemistry: A Global Perspective." *J. Geophys. Res.*, 86(C8), 7210-7254, 1981

Lorius C., Raynaud D., and Dolle L. "Densite de la glace et etude des gaz en profondeur dans un glacier antarctique." *Tellus*, XX(3), 449-459, 1968

Lukshin V.V., Mateveyeva O.A., and Sklyarenko I.Ya. "Determination of Surface-Atmosphere Methane Concentrations." *Izvestiya, Atm. Oce. Phys.*, 13(1), 66-68, 1977

Lukshin V.V., Matveyeva O.A., and Sklyarenko I.Ya. "Determination of the Flux of Atmospheric Methane from Earth's Surface." *Izvestiya, Atm. Oce. Phys.*, 14(1), 45-49, 1978

Lukshin V.V., and Sklyarenko I.Ya. "Synchronous Measurements of Methane Abundance in the Surface Layer and Vertical Column of the Atmosphere." *Izvestiya, Atm. Oce. Phys.*, 15(2), 148-152, 1979a

Lukshin V.V., and Sklyarenko I.Ya. "Estimate of Global Anthropogenic Emissions of Methane into the Atmosphere." *Izvestiya, Atm. Oce. Phys.*, 15(4), 314-315, 1979b

Malkov I.P., Dianov-Klokov V.I., and Lukshin V.V. "Measurements of Methane Concentration Distribution in the Northern and Southern Hemispheres." *Izvestiya, Atm. Oce. Phys.*, 16(7), 540-549, 1980

Matsuo S., and Miyake Y. "Gas Composition in Ice Samples from Antarctica." *J. Geophys. Res.*, 17(22), 5235-5241, 1966

Mayer E.W., Rowland F.S., Makide Y. "Interhemispheric Gradient of Atmospheric Methane Between the Northern and Southern Hemispheres, 1978." Paper presented at the Division of Environmental Chemistry, American Chemical Society, Honolulu, Hawaii, April 1-6, 1979

Mayer E.W., Blake D.R., Tyler S.C., Makide Y., Montague D.C., and Rowland F.S. "Methane: Interhemispheric Concentration Gradient and Atmospheric Residence Time." *Proc. Natl. Acad. Sci. USA*, 79, 1966-1970, 1982

McMath R.R., Mohler O.C., and Goldberg L. "Telluric Bands of Methane in the Fraunhofer Spectrum." *Phys. Rev.*, 73, 1203-1204, 1948a

McMath R.R., Mohler O.C., Goldberg L. "The Abundance and Temperature of Methane in the Earth's Atmosphere." *Phys. Rev.*, 74, 623-624, 1948b

McMath R.R., Mohler O.C., and Goldberg L. "Telluric Bands of Methane in the Solar Spectrum." *Astrophys. J.*, 109, 17-27, 1949

Migeotte M.V. "Methane in the Earth's Atmosphere." *J. Astrophys.*, 107, 400-403, 1948a

Migeotte M.V. "Spectroscopic Evidence of Methane in the Earth's Atmosphere." *Phys. Rev.*, 73, 519-520, 1948b

Migeotte M.V. "Lines of Methane at  $7.7\mu$  in the Solar Spectrum." *Phys. Rev.*, 74, 112-113, 1948c

Newell R.E., Condon E.P., and Reichle Jr. H.G. "Measurements of CO and CH<sub>4</sub> in the Troposphere over Saudi Arabia, India and Arabian Sea during the 1979 International Summer Monsoon Experiment(MONEX)." *J. Geophys. Res.*, 86(C10), 9883-9888, 1981

Nielsen A.H., and Migeotte M. "Abundance and Vertical Distribution of Telluric Methane from Measurements at 3580 Meters Elevation." *Annales d' Astrophysique*, 15(2), 134-141, 1952

*Global Tropospheric Chemistry: A Plan for Action* National Research Council, 1984

Ortman G.C. "Monitoring Methane in Atmosphere with a Flame Ionization Detector." *Anal. Chem.*, 38(4), 644-646, 1966

Owens A.J., Steed J.M., Filkin D.L., Miller C., and Jesson J.P. "The Potential Effects of Increased Methane on Atmospheric Ozone." *Geophys. Res. Lett.*, 9(9), 1105-1108, 1982

Ramanathan V., Cicerone R.J., Singh H.B., and Kiehl J.T. "Trace Gas Trends

and Their Potential Role in Climate Change." *J. Geophys. Res.*, 90(D9), 5547-5566, 1985

Rasmussen R.A., and Khalil M.A.K. "Increase in the Concentration of Atmospheric Methane." *Atmos. Env.*, 15(5), 889-886, 1981a

Rasmussen R.A., and Khalil M.A.K. "Atmospheric Methane( $CH_4$ ): Trends and Seasonal Cycles." *J. Geophys. Res.*, 86(C10), 9826-9832, 1981b

Rasmussen R.A., Khalil M.A.K., and Hoyt S.D. "Methane and Carbon Monoxide in Snow." *JAPCA*, 32(2), 176-178, 1982

Rasmussen R.A., and Khalil M.A.K. "Global Production of Methane by Termites." *Nature*, 301, 700-701, 1983

Rasmussen R.A., and Khalil M.A.K. "Atmospheric Methane in Recent and Ancient Atmospheres: Concentrations, Trends, and Interhemispheric Gradient." *J. Geophys. Res.*, 89(D7), 11599-11605, 1984

Raynaud D., and Lorius C. "Climatic Implications of Total Gas Content in Ice at Camp Century." *Nature*, 249, 283-284, 1979

Raynaud D., and Lebel B. "Total Gas Content and Surface Elevation of Polar Ice Sheets." *Nature*, 281, 289-291, 1979

Reichle Jr. H.G., and Condon E.P. "Vertical Profiles of CO and  $CH_4$  in the Lower and Middle Troposphere over the Eastern United States, January 1978." *Geophys. Res. Lett.*, 6(12), 949-951, 1979

Rinsland C.P., Levine J.L., and Miles T. "Tropospheric Methane Concentration Deduced from 1951 Infrared Solar Spectra." *Nature*, 1985 (in print)

Robbins R.C., Cavanaugh L.A., and Salas L.J. "Analysis of Ancient Atmospheres." *J. Geophys. Res.*, 78(24), 5941-5944, 1979

Scholander P.F., Hemmingsen E.A., Coachman L.K., and Nutt D.C. "Composition of Gas Bubbles in Greenland Icebergs." *J. Glaciology*, 3, 818-822, 1961

Schwander J., and Stauffer B. "Age Difference between Polar Ice and the Air Trapped in its Bubbles." *Nature*, 311, 45-47, 1984

Seiler W., Muller F., and Oeser H. "Vertical Distribution of Chlorofluoromethanes in the Upper Troposphere and Lower Stratosphere." *Pure Appl. Geophys.*, 116, 554-566, 1978

Sheppard J.C., Westberg H., Hopper J.F., Ganesan K., and Zimmerman P. "Inventory of Global Methane Sources and Their Production Rates." *J. Geophys.*

*Res.*, 87(C2), 1905-1912, 1982

Singh H.B., Sala L.J., Shigeishi H., and Scribner E. "Atmospheric Halocarbons, Hydrocarbons, and Sulfur Hexafluoride: Global Distributions, Sources, and Sinks." *Science*, 209, 899-909, 1979

Singh H.B., and Salas L.J. "Measurement of Selected Light Hydrocarbons over the Pacific Ocean: Latitudinal and Seasonal Variations." *Geophys. Res. Lett.*, 9(8), 842-845, 1982

Snedecor G.W., and Cochran W.G. *Statistical Methods*, Iowa State University Press, Ames, Iowa, 1980

Stauffer B., Fischer G., Neftel A., and Oeschger H. "Increase of Atmospheric Methane Recorded in Antarctic Ice Core." *Science*, 229, 1986-1988, 1985

Steele L.P., Fraser P.J., Rasmussen R.A., Khalil M.A.K., Crawford A.J., Conway T.J., and Gammon R.H. "Global Atmospheric Measurements of CH<sub>4</sub> and CO<sub>2</sub> by Gas Chromatography." *NOAA Summary Report*, 163-165, 1988

Steele L.P., Fraser P.J., Rasmussen R.A., Khalil M.A.K., Crawford A.J., Conway T.J., and Gammon R.H. "Global Measurements and Distribution of Methane." *J. Atmos. Chem.*, 1985 (submitted)

Stephens E.R., and Burleson F.R. "Distribution of Light Hydrocarbons in Ambient Air." *JAPCA*, 19(12), 929-936, 1969

Stephens E. R. "Tropospheric Methane: Some Old Measurements." *Geophys. Res. Lett.*, 1985 (to appear)

Stevens C.M. and Rust F.E. "The Carbon Isotopic Composition of Atmospheric Methane." *J. Geophys. Res.*, 87(C7), 4879-4882, 1982

Swinnerton J.W., Linnenbom V.J., and Cheek C.H. "Distribution of Methane and Carbon Monoxide between the Atmosphere and Natural Waters." *Env. Sci. Tech.*, 3(9), 896-898, 1969

Sze N.D. "Anthropogenic CO Emissions: Implications for the Atmospheric CO-OH-CH<sub>4</sub> Cycle." *Science*, 195, 678-675, 1977

Walker J.C.G. "Evolution of the Atmosphere." *Macmillan*, New York, 1977

Wang W.C., Yung Y.L., Lacis A.A., Mo T., and Hansen J.E. "Greenhouse Effects due to Man Made Perturbations of Trace Gases." *Science*, 194, 685-690, 1976

Wilkniss P.E., Lamontagne R.A., Larson R.E., Swinnerton J.W., Dickson C.R., and Thompson T. "Atmospheric Trace Gases in the Southern Hemisphere." *Nature*,

245, 45-47, 1979

Wilkniss P.E., Swinnerton J.W., Bressen D.J., Lamontagne R.A., and Larson R.E. "CO, CCl<sub>4</sub>, Freon-11, CH<sub>4</sub>, and Rn-222 Concentrations at Low Altitudes over the Arctic Ocean in January 1974." *J. Atmos. Sci.*, 32, 158-162, 1975

Wilkniss P.E., and Larson R.E. "Atmospheric Radon Measurements in the Arctic; Fronts, Seasonal Observations, and Transport of Continental Air to Polar Regions." *J. Atmos. Sci.*, 41(15), 2947-2958, 1984

Wofsy S.C., McConnell J.C., and McElroy M.B. "Atmospheric CH<sub>4</sub>, CO, and CO<sub>2</sub>." *J. Geophys. Res.*, 77(24), 4477-4499, 1972

Wofsy S.C. "Interactions of CH<sub>4</sub> and CO in the Earth's Atmosphere." *Ann. Rev. Earth Planet. Sci.*, 4, 441-469, 1976

Yurganov L.N., Malkov I.P., and Dianov-Klokov V.I. "Study of the Abundance of Minor Atmospheric Components in Northern and Southern Hemispheres." *Izvestiya, Atm. Oce. Phys.*, 15(11), 807-812, 1979

## Vita

The author was born in Tiruchirapalli, India on January 25, 1959. He attended Regional Engineering College, Warangal, India and received his B.Tech. degree in Chemical Engineering in 1981. He then joined Engineers India Limited, New Delhi, India in July, 1981 and spent the following two and a half years as an Environmental Engineer in the Environmental Engineering Group. In December, 1983 the author came to the United States to pursue graduate studies at the Oregon Graduate Center where he completed the requirements for the degree of Master of Science in October, 1985.

The author is a member of American Geophysical Union, Air Pollution Control Association, and the American Chemical Society.